



Partnering with India in Building a Better Tomorrow

We are India's largest home and institutional furniture manufacturer since 1936. With a focus on Make in India products, manufactured in state-of-the-art facilities that meet global design, quality, and testing standards.

Committed to modern nation-building, we deliver products, services, and initiatives that drive a greener, healthier, more progressive, and prosperous future.



125+ Years of Legacy 1000+ Projects Delivered Annually

With a rich legacy that spans over 125 years, Godrej is a pioneer across industries in India.

Led by India's largest in-house furniture design team, our aim is to transform spaces with thoughtfully-designed furniture. And our goal is to create brighter homes and offices with products that have the highest design quotient in aesthetics, functionality, and technology.

Godrej Interio at a glance

- India's largest home and institutional furniture manufacturer, since 1936; supporting nation building
- 95% ex-works TOC performance through project tools and dedicated team to ensure on-time project delivery
- Unique customisation capabilities
- Winner of 34 India Design Mark Awards to date

Widest product portfolio across product lines

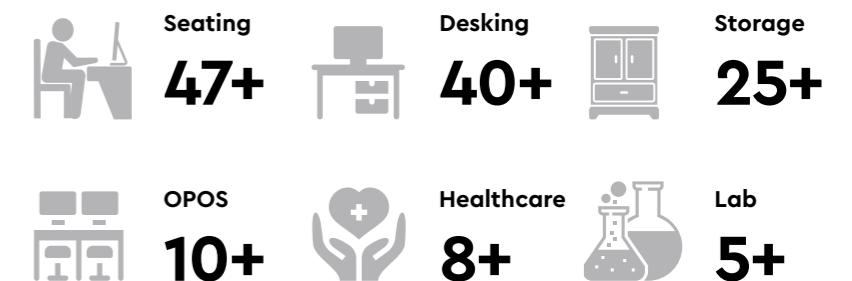

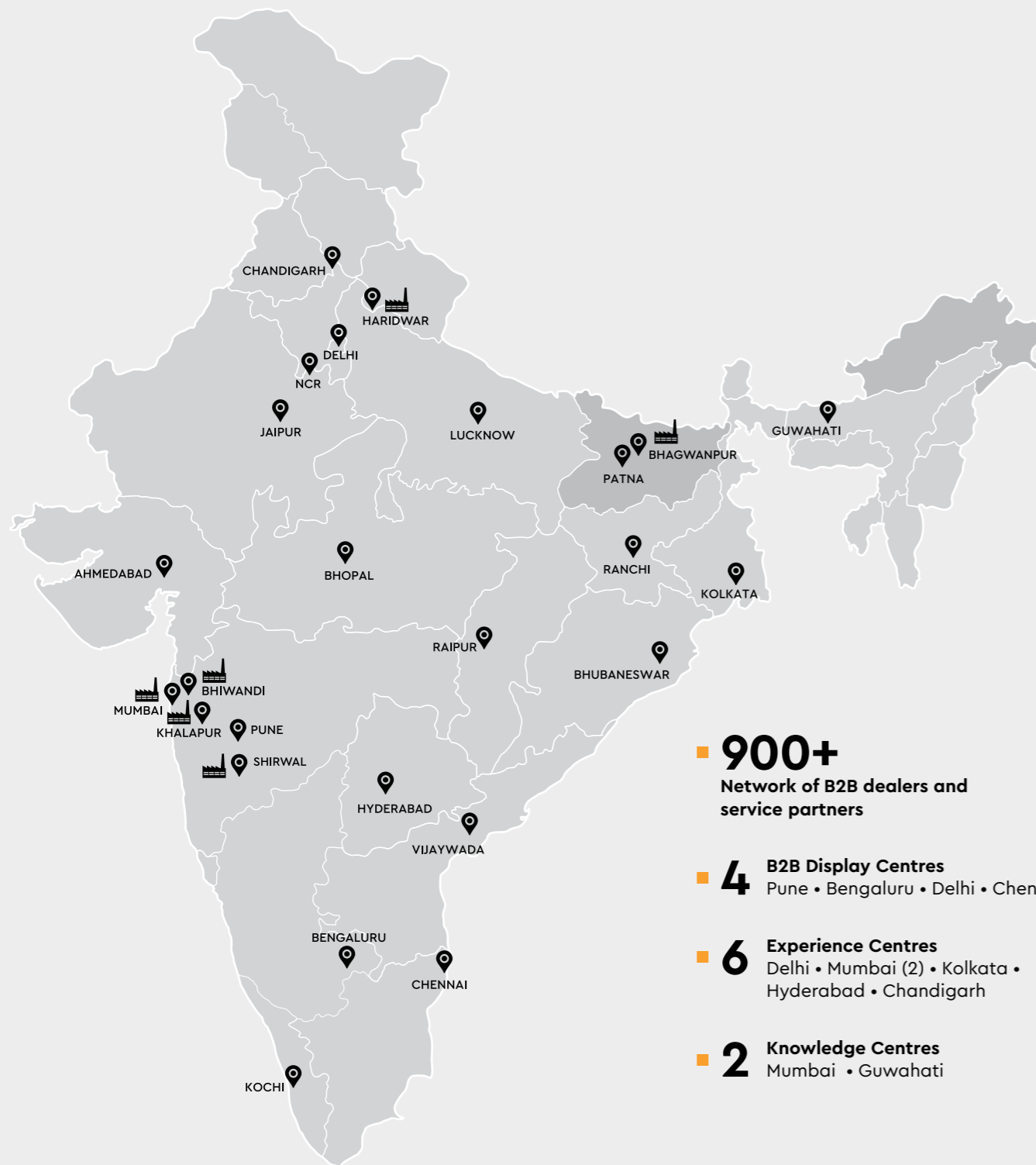

- **900+**
Network of B2B dealers and service partners
- **4** B2B Display Centres
Pune • Bengaluru • Delhi • Chennai
- **6** Experience Centres
Delhi • Mumbai (2) • Kolkata • Hyderabad • Chandigarh
- **2** Knowledge Centres
Mumbai • Guwahati

Our All-India Presence

Get complete access to our wide range of educational solutions across our 900+ dealers and partners in India. Manufactured at our facilities in Vikhroli, Shirwal, Khalapur, Haridwar, and Bhagwanpur, all our products pass through multiple stringent quality checks before they reach you.

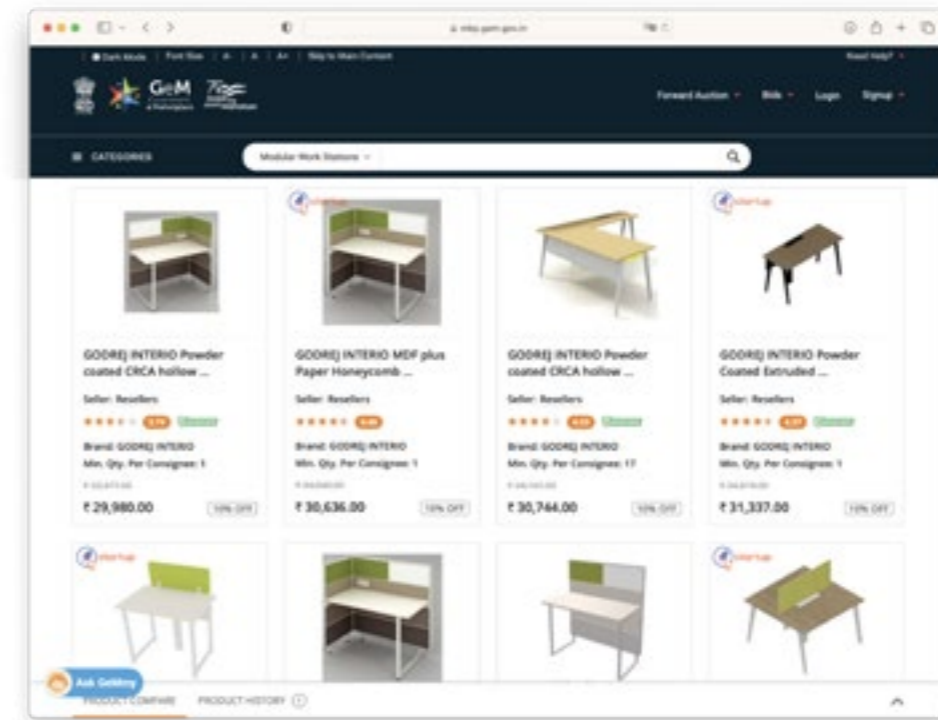

Rating of 4+ on GeM Compliant and Widely Available

Godrej Interio is the largest umbrella brand listed on the GeM portal: in 80+ categories under furniture and 190+ categories under office space. Interio has an overall rating of 4+ based on various parameters such as Delivery, Quality, Reliability and Feedback by buyers.

- Among **Top 15** Sellers Registered On GeM
- **60,000+** Product Listings
- **365+** Re-seller Network
- **100+** GeM Categories
- Products Listed In This Dossier Are Available On GeM Portal
- Additional Products Can Be Made Available As Per Requirement

Enforcing Green at Every Step

At Godrej Interio, our sustainability goals are ambitious. We do not just talk, we walk the talk.

We take our work seriously because we know our products and services touch people, transform lives, and change the world.

When we add the element of sustainability and green living into what we do, we infuse hope giving life to the promise of a better future, not only for people but for the planet as a whole.

Godrej interio
talk green.
walk green.



Materials

- Design for Environment
- Green Materials
- LCA



Transportation

- Green Modes of Transportation



Manufacturing

- Energy Efficiency
- Zero Waste Water Discharge
- Renewal Energy
- Zero Waste Landfill



In Use

- Low Emitting Products
- Green Certification
- AMC



Packaging

- Flat Packaging
- Right Packaging



End Of Life

- Recycling Programme
- Safe Disposal

India's First Net Zero Energy Building.

- CII certified state-of-the-art manufacturing facilities across 6 locations
- Designed for the environment: Cradle to grave journey monitored



Largest Portfolio of Certified Products

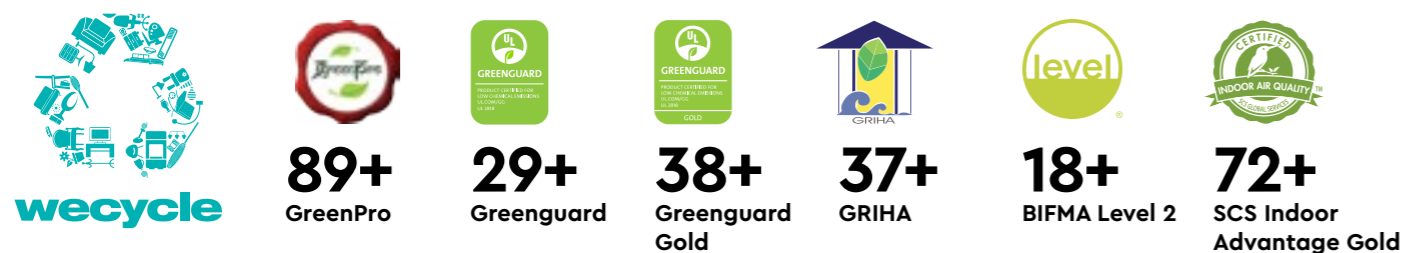

Towards Healthier Workspaces

Godrej interio
wellness@work

- Team of certified doctors / ergonomists to assist employee health and productivity challenges at workplace

- Ergonomics Programme helps organisations improve employee comfort, lowers injuries arising out of sedentary lifestyle at work

- Initiatives help reduce healthcare cost

- Team is backed by research and advisory experience spanning corporate, government and healthcare organisations



Awards and Recognitions



Brand of The Year
Marksmen Daily
2023-2024



India's Most Trusted Brand
TRA Research
Furniture Category
February 2022



India's Most Desired Brand
TRA Research
Furniture Category
July 2021



Franchise India
Retail Brand of the Year
Speciality/Furniture
Retail Category
December 2022



India Design Mark
A recipient of 34 India
Design Mark Awards,
and counting.



Super Brand Award
Godrej Interio
received award at the
SuperBrands event
held in Delhi.



GreenCo Best Practices Award

Godrej Interio
received award at
the 17th CII National
Energy Summit.



Energy-Efficient Unit Award

Godrej Interio Vikhroli
Plant received award
at the 17th CII National
Energy Summit.



Energy-Efficient Unit Award

Godrej Interio Shirwal
Plant received award
at the 17th CII National
Energy Summit.

Desking

Page 16

Premium Suites

Page 36

Executive Suites

Page 49

Office Desks

Page 60

Conference Table

Page 72

Reception Table

Page 74

Training Table

Page 75

Cafeteria and Breakout Tables

Grandeur



Features

- The Godrej Interio Grandeur Premium Suite epitomises executive excellence with a harmonious blend of modern functionality and timeless aesthetics.
- India's first AV-ready suite features integrated AV connections, efficient wire management, and a swivel-and-tilt display mount. Includes a desk pad, wireless charger, and height-adjustable return table for ergonomic comfort.
- Seamlessly transitions between focused tasks and AV-enabled meetings, delivering a modern, productive workspace that makes it an ideal choice for high-level professionals seeking functionality and sophistication.

In the set above

Grandeur Premium Suite

1800w Main Table + ERU

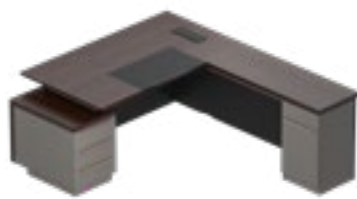

Medium Back Unit



Pair with

Tall Back Unit 2325H



Compact Storage 3000w



Grandeur Side Table



Grandeur Coffee Table



Grandeur Premium Suite

Features

- Truly modular design offers spacious main tables and ERUs with flexible configurations tailored to specific needs, including height-adjustable options for ergonomic flexibility.
- Meticulous detailing with worktop featuring an overhang on all four sides for a sleek, modern floating effect. Rose-gold aluminium trims and premium accents across the entire suite deliver a cohesive and sophisticated look.
- Integrated AV-ready power box with HDMI outlets reduces clutter and supports seamless connectivity. A range of back units, from low-height ERUs which can double up as back units to towering storage, ensure practicality and elegance.

Measurements

Desk

1800w Main Table + ERU

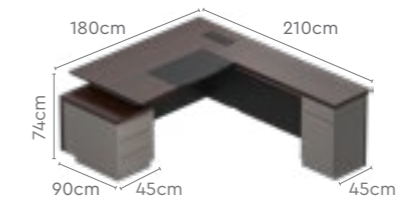

2400w Main Table

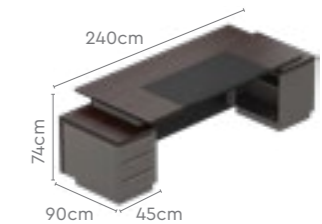

2400w Main Table + 1200w ERU

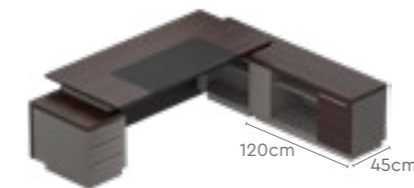

3000w Main Table

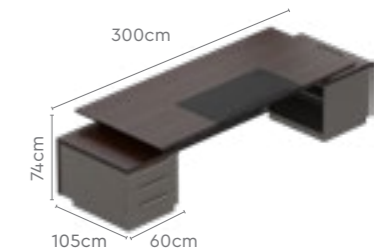

3000w Main Table + 1500w ERU

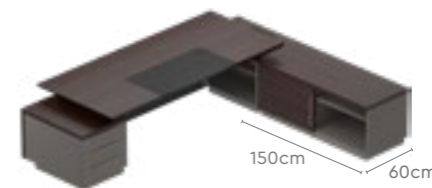

3000w Main Table + 1500w Height Adjustable ERU

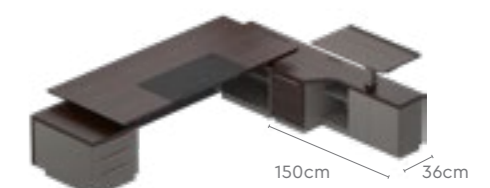

Back Storage Units

Tall Back Unit 2325H

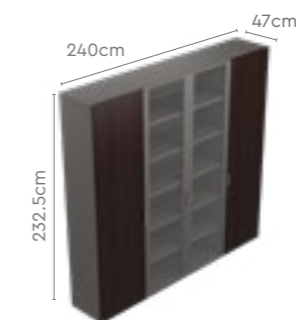

Tall Back Unit 1950H

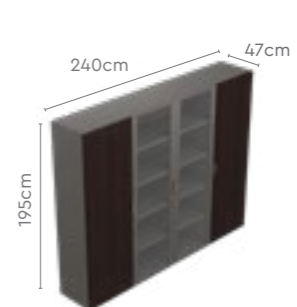

Medium Back Unit

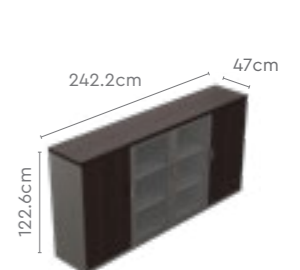

Grandeur Premium Suite

Features

- The suite features a range of compact and versatile back storage units and allied products that align with the main desk's premium design. The elegant Grandeur side and coffee tables keep the workspace neat and organised, empowering focus without distractions.
- The Team Discussion Table's optional retrofit display attachment invites flexible interaction, ideal for brainstorming. The Grandeur Display Mount supports modern AV setups, meeting the needs of dynamic presentations and collaboration.
- The 3-point locking mechanism secures materials, ensuring safety.

Measurements

Back Storage Units

Compact Storage 3000w

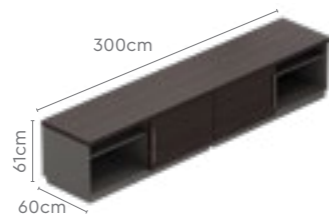

Compact Storage 2400w

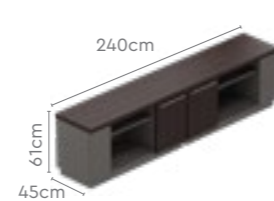

Grandeur Side Table

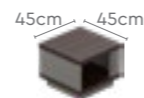

Grandeur Coffee Table

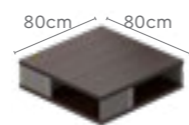

Allied Products (Available for 2400w & 3000w Main Table)

Team Discussion Table

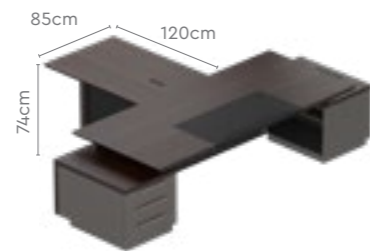

Grandeur Display Mount



Supports 40" and 43" Displays only.

All sizes in cm	Width	Depth
1800w Main Table + ERU	180.0	210.0
2400w Main Table	240.0	90.0
3000w Main Table	300.0	105.0
1200w ERU	120.0	45.0
1500w ERU	150.0	60.0
1500w Height Adjustable ERU	150.0	60.0
Tall Back Unit 2325H	240.0	47.0
Tall Back Unit 1950H	240.0	47.0
Medium Back Unit	242.4	47.0
Compact Storage 2400w	240.0	45.0
Compact Storage 3000w	300.0	60.0
Grandeur Side Table	45.0	45.0
Grandeur Coffee Table	80.0	80.0
Team Discussion Table	120.0	85.0
Grandeur Display Mount	62.5	11.0

Coeval



Design Registered

Features

- High-gloss panels with a PU finish. Genuine leather padding on the top surface and a toughened streak glass modesty for the main desk section.
- Available in multiple options in return units to match various preferences.
- Convenient push-to-open feature for all of its drawers.
- Multiple storage options are provided in the form of back units, storage units, and pedestals.
- The display unit has adjustable LED lights controlled by sensors.

In the set above

Coeval Premium Suite

Main Desk

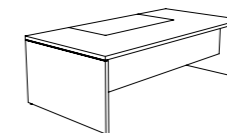

Return Unit 700D

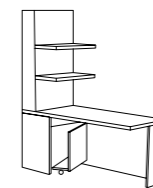

Flap Up Unit

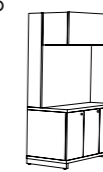

Display Unit



Pair with

Return Unit 550D



Independent Low Height Return Unit

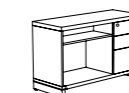

Medium Height Back Unit



Marvel High Back Chair

→ Pg 86



Table Height Back Unit

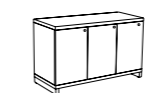

Pedestal

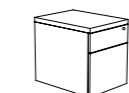

Wardrobe Unit



Coeval Premium Suite

Measurements

Main Desk Option 1

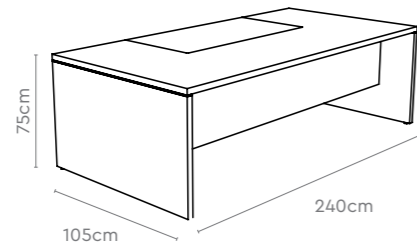

Main Desk Option 2

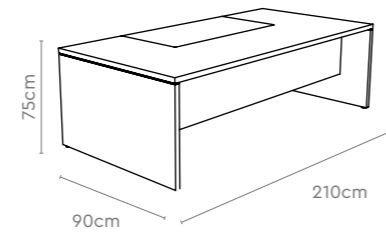

Return Units LH & RH

Return Unit 700D LH

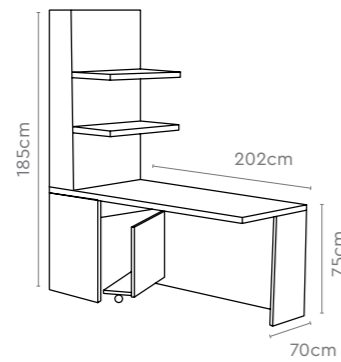

Return Unit 550D LH

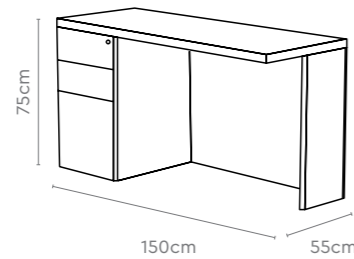

Independent Low Height Return Unit LH

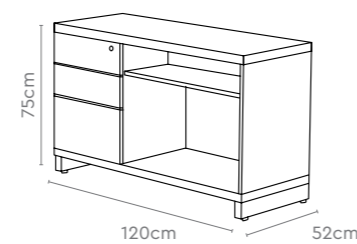

All sizes in cm	Width	Depth	Height	Height 2
Main Desk Option 1	240.0	105.0	75.0	-
Main Desk Option 2	210.0	90.0	75.0	-
Independent Low Height Return Unit	120.0	52.0	75.0	-
Return Unit 550D	150.0	55.0	75.0	-
Return Unit 700D	202.0	70.0	185.0	75.0

Coeval Premium Suite

Measurements

Medium Height Back Unit

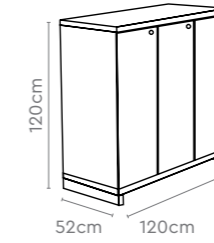
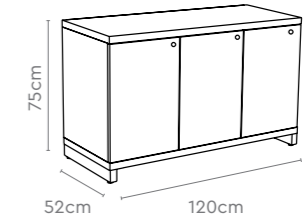
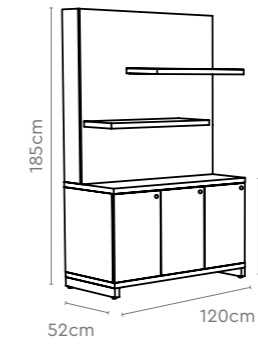

Table Height Back Unit



Display Unit



Flap-Up Unit

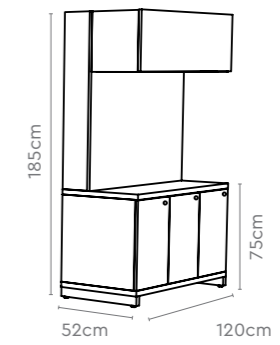

Wardrobe Unit

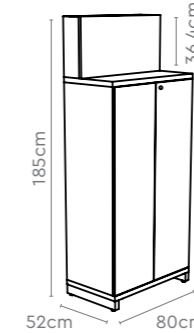

Pedestal

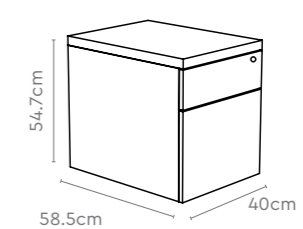

All sizes in cm	Width	Depth	Height	Height 2
Medium Height Back Unit	120.0	52.0	120.0	-
Table Height Back Unit	120.0	52.0	75.0	-
Display Unit	120.0	52.0	185.0	75.0
Flap-Up Unit	120.0	52.0	185.0	75.0
Wardrobe Unit	80.0	52.0	185.0	36.4
Pedestal	40.0	58.5	54.7	-

Aristo



Design Registered



Features

- The Aristo comes complete with softened corners and chamfered edges that offer user comfort and convenience.
- Its simple horizontal line pattern and dark wood grains make for an elegant finish.
- The soft-close sliding doors, with aluminium handles for back units, ensure ease of operation.

In the set above

Aristo Premium Suite

Main Table + ERU
(with or without Pedestal)

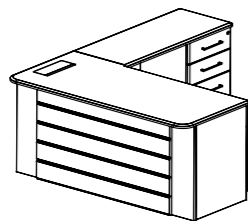

Back Unit 1

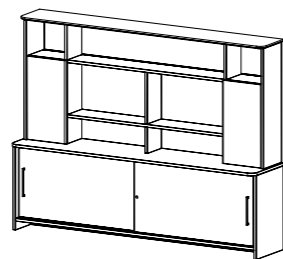

Pair with

Back Unit 1

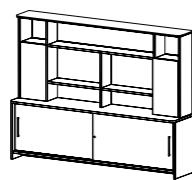

Back Unit 2

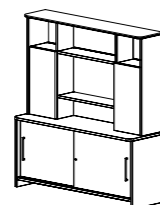

Back Unit 4

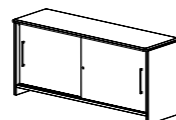

Marvel High Back Chair

→ Pg 86



Aristo Premium Suite

Measurements

Main Table + ERU RH
(with or without Pedestal)

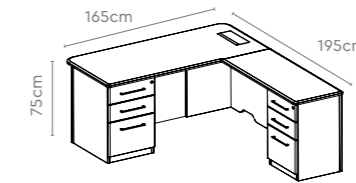

Main Table + ERU LH
(with or without Pedestal)

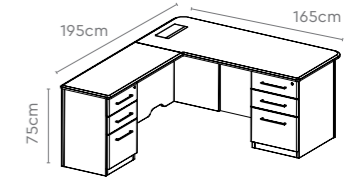

Back Unit 1

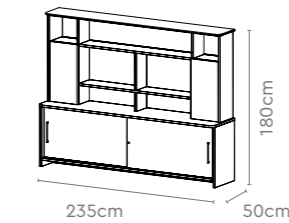

Back Unit 2

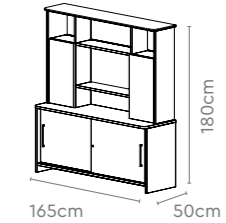

Back Unit 3

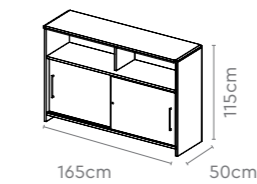

Back Unit 4

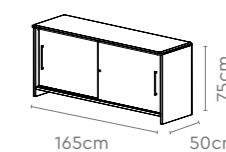

All sizes in cm

	Width	Depth	Height
Main Table + ERU with Pedestal	165.0	195.0	75.0
	180.0	210.0	75.0
	210.0	225.0	75.0
	235.0	235.0	75.0
Main Table + ERU (W/o ERU Pedestal)	165.0	165.0	75.0
Back Unit 1	235.0	50.0	180.0
Back Unit 2	165.0/180.0	50.0	180.0
Back Unit 3	165.0/180.0/235.0	50.0	115.0
Back Unit 4	165.0/180.0/235.0	50.0	75.0

Topaz



Design Registered



Features

- The clean lines on the Topaz desk surface blend well with its raw wood grain and aesthetic door handles.
- Geometric lines run throughout the panel, making optimum use of lighter shades to present a uniform and neat look.
- The unique pattern on the fascia and the modesty panel, ups the style quotient of any space the Topaz sits in.

In the set above

Topaz Premium Suite

Main Table + ERU
(with or without Pedestal)

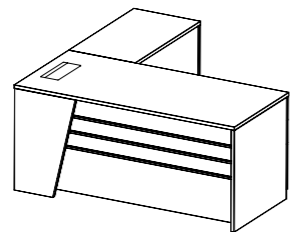

Back Unit 3

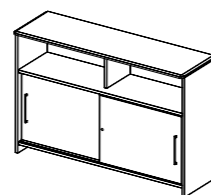

Pair with

Back Unit 1

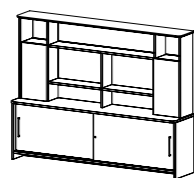

Back Unit 2

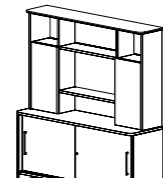

Back Unit 4

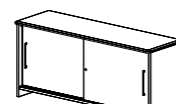

Ace Full Back Chair



Topaz Premium Suite

Measurements

Main Table + ERU RH
(with or without Pedestal)

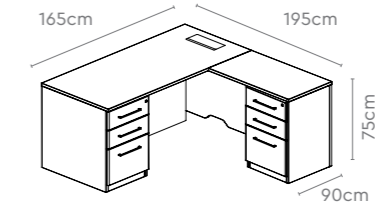

Main Table + ERU LH
(with or without Pedestal)

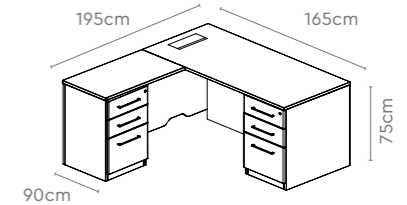

Back Unit 1

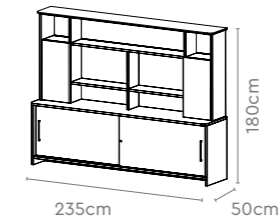

Back Unit 2

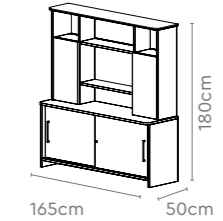

Back Unit 3

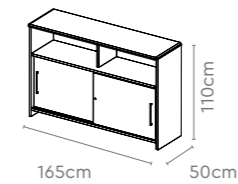

Back Unit 4

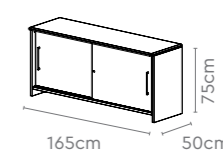

All sizes in cm

	Width	Depth	Height
Main Table + ERU with Pedestal	165.0	195.0	75.0
	180.0	210.0	75.0
	210.0	225.0	75.0
	235.0	235.0	75.0
Main Table + ERU (W/o ERU Pedestal)	165.0	165.0	75.0
Back Unit 1	235.0	50.0	180.0
Back Unit 2	165.0/180.0	50.0	180.0
Back Unit 3	165.0/180.0/235.0	50.0	110.0
Back Unit 4	165.0/180.0/235.0	50.0	75.0

Cignus



Design Registered



Features

- The Cignus desk stands out with its swan-like flowing design, vividly enhanced by a contrasting colour scheme.
- The return unit features a partial chamfer that enhances the comfort of the user.
- The flowing lines on the Cignus are seamlessly continued on its modesty. The panel features a stylish slanted cut that perfectly complements the return unit.

In the set above

Cignus Premium Suite

Main Table + ERU (with or without Pedestal)

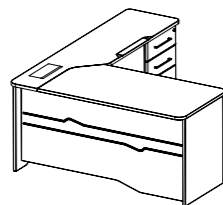

Back Unit 1

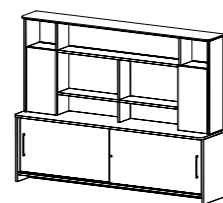

Back Unit 2

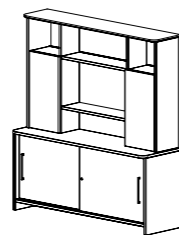

Pair with

Back Unit 3

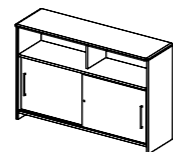

Back Unit 4

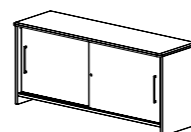

Marvel High Back Chair

→ Pg 86



Cignus Premium Suite

Measurements

Main Table + ERU RH (with or without Pedestal)

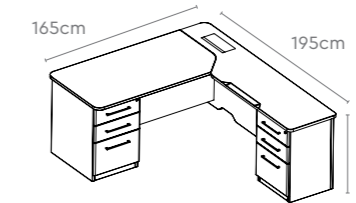

Main Table + ERU LH (with or without Pedestal)

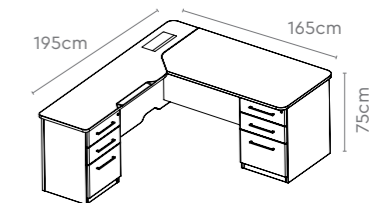

Back Unit 1

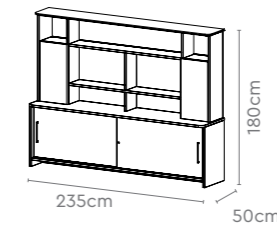

Back Unit 2

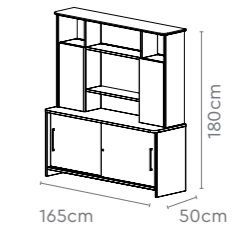

Back Unit 3

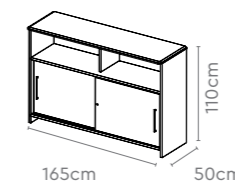

Back Unit 4

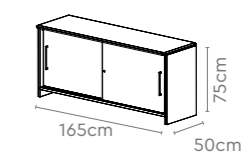

All sizes in cm

	Width	Depth	Height
Main Table + ERU with Pedestal	165.0	195.0	75.0
	180.0	210.0	75.0
	210.0	225.0	75.0
	235.0	235.0	75.0
Main Table + ERU (W/o ERU Pedestal)	165.0	165.0	75.0
Back Unit 1	235.0	50.0	180.0
Back Unit 2	165.0/180.0	50.0	180.0
Back Unit 3	165.0/180.0/235.0	50.0	110.0
Back Unit 4	165.0/180.0/235.0	50.0	75.0

Arrive



Features

- An elegant design that perfectly embodies sophistication and prestige.
- Durable all-veneer desk with a soft black leather pad on top for a luxurious touch.
- The main desk is equipped with a convenient pull-out keyboard tray.
- This sleek design includes a smart case-space that effortlessly slides in.
- Perfect for storing files and papers, keeping the desk clutter-free.

In the set above

Arrive Premium Suite



Main Desk

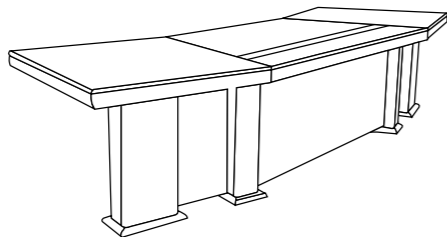

Mobile Cabinet

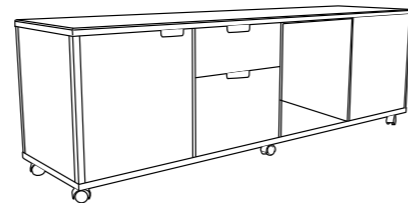

Pair with

Mobile Pedestal



Back Unit

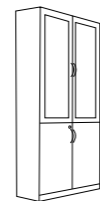

Pulse High Back Chair



Arrive Premium Suite

Measurements

Main Desk

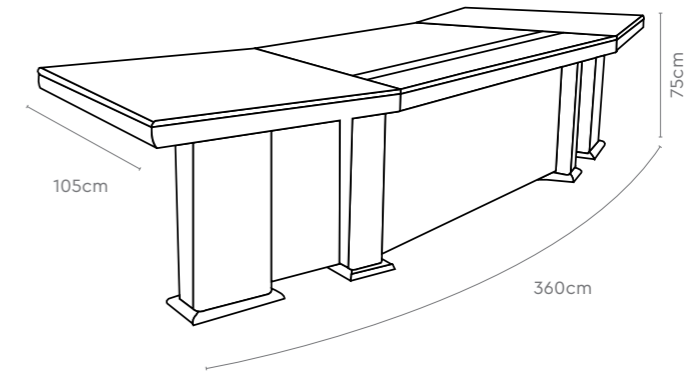

Mobile Cabinet

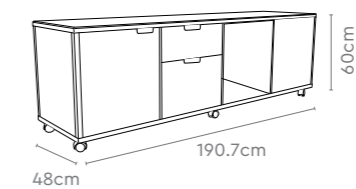

Pedestal

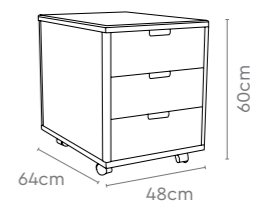

Back Unit

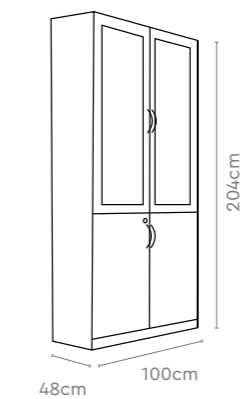

All sizes in cm

	Width	Depth	Height
Main Desk	360.0	105.0	75.0
Mobile Cabinet	190.7	48.0	60.0
Pedestal	48.0	64.0	60.0
Back Unit	100.0	48.0	204.0

Impress



Features

- The Impress Desk comes with a veneer finish that gives it a premium feel and aesthetic.
- The leather padding across its width reduces wear and tear, while ensuring complete comfort while working.
- Enjoy a clutter-free workspace, thanks to its efficient wire management provisions.
- The side unit can be placed on either side of the user, and comes with ample storage space.

In the set above

Impress Premium Suite



Executive Desk

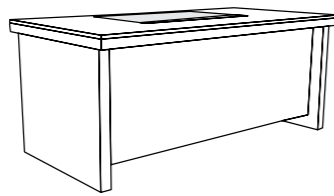

Credenza

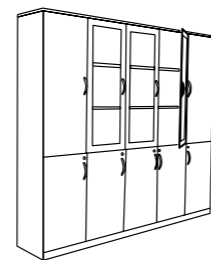

Mobile Side Unit

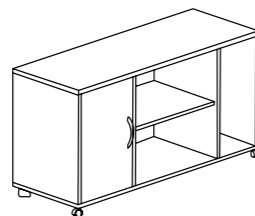

Mobile Pedestal



Pair with

Pulse High Back Chair



Impress Premium Suite

Measurements

Executive Desk

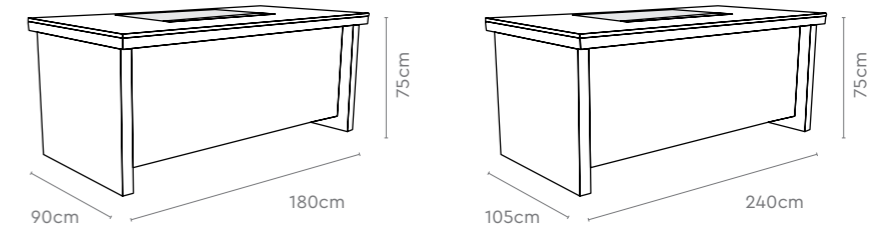

Mobile Side Unit

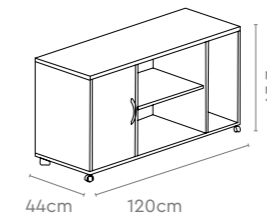

Mobile Pedestal



Credenza

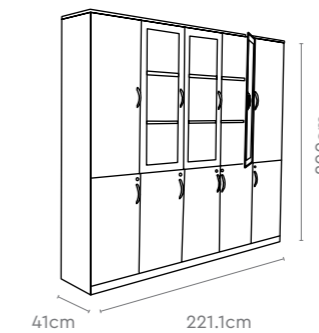

All sizes in cm

	Width	Depth	Height
Executive Desk	180.0	90.0	75.0
	240.0	105.0	75.0
Mobile Side Unit	120.0	44.0	63.7
Mobile Pedestal	44.3	51.0	62.5
Credenza	221.1	41.0	200.0

Jefferson Presidential Suite



Features

- At first glance, it is easy to see why the Jefferson Presidential Suite is deserving of its name.
- Made with natural veneer, it exudes prestige in every intricate detail.
- The spacious curvilinear worktop fosters quick team meetings and discussions.
- Its polyester finish is resistant to scratches and stains.
- Get the full presidential look with a matching side unit, back unit, and tower case.

In the set above

Jefferson Presidential Suite

Executive Desk

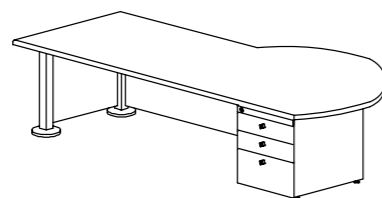

L.H.S R.H.S

Tower Unit

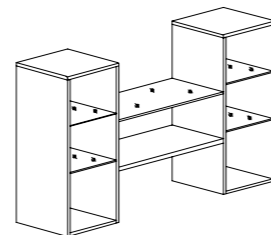

Side Unit

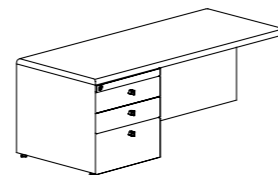

Pair with

Back Unit

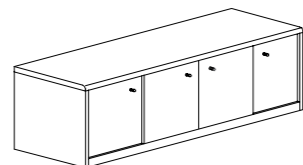

Ace Full Back Chair



Jefferson Presidential Suite

Measurements

Executive Desk

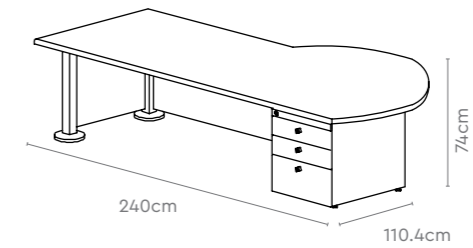

L.H.S R.H.S

Side Unit

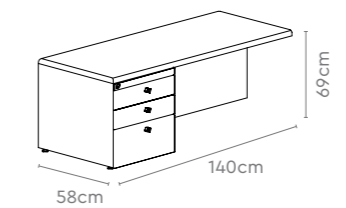

Back Unit

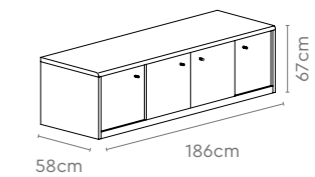

Tower Unit

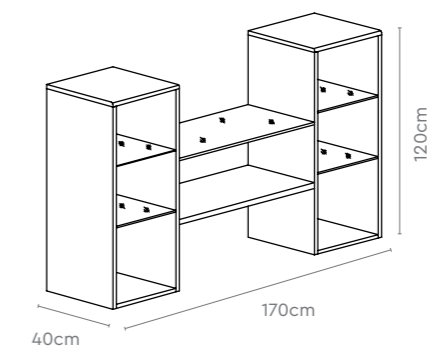

All sizes in cm

	Width	Depth	Height
Executive Desk	240.0	110.4	74.0
Side Unit	140.0	58.0	69.0
Back Unit	186.0	58.0	67.0
Tower Unit	170.0	40.0	120.0

Maestro



Features

- The Maestro's Duck Nose profile edge enhances your workplace's aesthetics.
- Comes with a side unit with a pedestal, and an extended table for extra storage.
- The pedestal stand with handles also adds to the overall style of your office space.
- Conduct impromptu meetings with ease, thanks to the joinery table.

In the set above

Maestro Premium Suite

Executive Desk

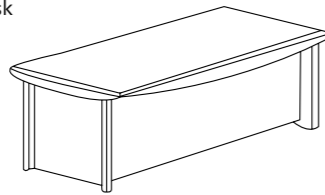

Side Unit

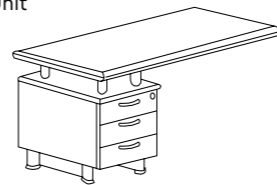

Joining Top

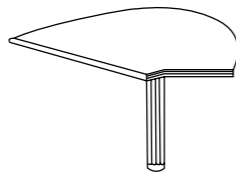

Bookcase Unit

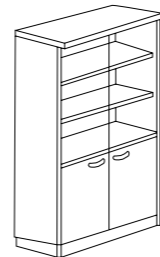

Credenza

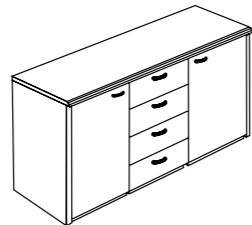

Pair with

Mobile Pedestal

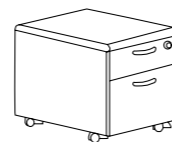

Maestro Premium Suite

Measurements

Executive Desk

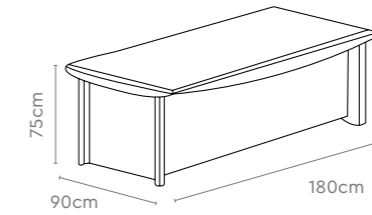

Side Unit

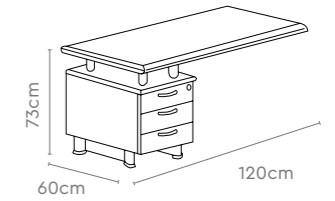

Joining Top

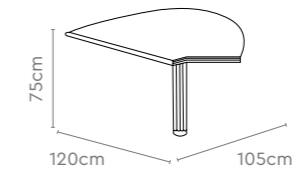

Bookcase Unit



Credenza

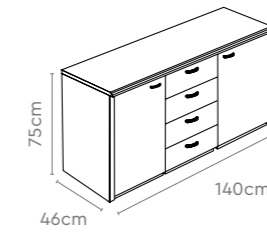

Mobile Pedestal

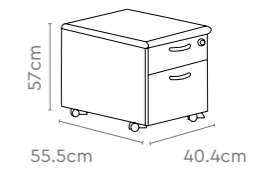

All sizes in cm

	Width	Depth	Height
Executive Desk	180.0	90.0	75.0
Side Unit	120.0	60.0	73.0
Joining Top	105.0	120.0	75.0
Bookcase Unit	79.5	40.0	202.0
Credenza	140.0	46.0	75.0
Mobile Pedestal	40.4	55.5	57.0

Aristo



Design Registered



Features

- The Aristo comes complete with softened corners and chamfered edges that offer user comfort and convenience.
- Its simple horizontal line pattern and dark wood grains make for an elegant finish.
- The soft-close sliding doors, with aluminium handles for back units, ensure ease of operation.

In the set

Aristo Executive Suite

Main Table

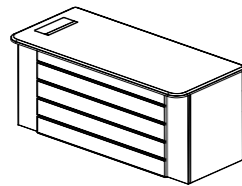

Back Unit 3

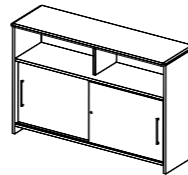

Back Unit 1

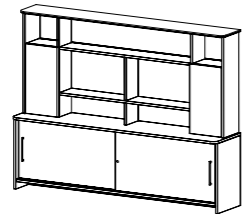

Back Unit 2

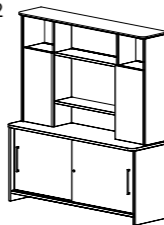

Pair with

Back Unit 4

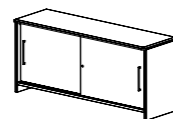

Aero High Back Chair



→ Pg 95

Aristo Executive Suite

Measurements

Main Table RH

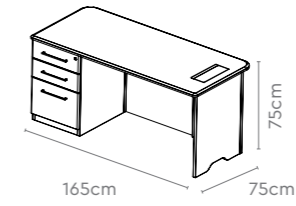

Main Table LH

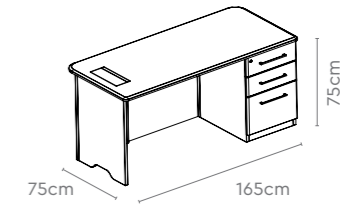

Back Unit 1

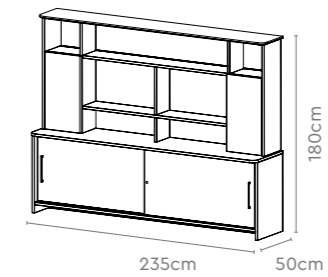

Back Unit 2

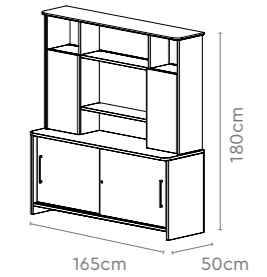

Back Unit 3

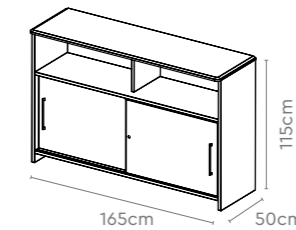

Back Unit 4

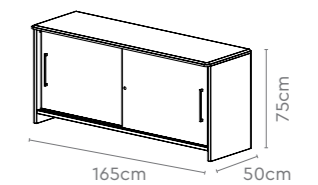

All sizes in cm

	Width	Depth	Height
Main Table	165.0	75.0	75.0
	180.0	90.0	75.0
Back Unit 1	235.0	50.0	180.0
Back Unit 2	165.0/180.0	50.0	180.0
Back Unit 3	165.0/180.0/235.0	50.0	115.0
Back Unit 4	165.0/180.0/235.0	50.0	75.0

Topaz



Design Registered



Features

- The clean lines on the Topaz desk surface blend well with its raw wood grain and aesthetic door handles.
- Geometric lines run throughout the panel, making optimum use of lighter shades to present a uniform and neat look.
- The unique pattern on the fascia and the modesty panel, ups the style quotient of any space the Topaz sits in.

In the set above

Topaz Executive Suite

Main Table

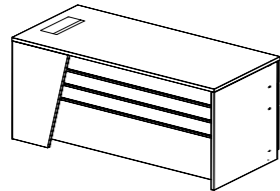

Back Unit 1

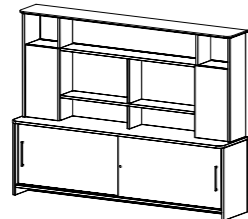

Back Unit 2

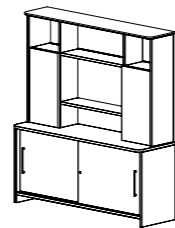

Pair with

Back Unit 3

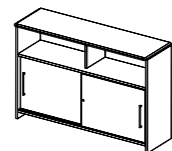

Back Unit 4

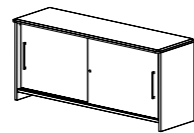

Topaz Executive Suite

Measurements

Main Table RH

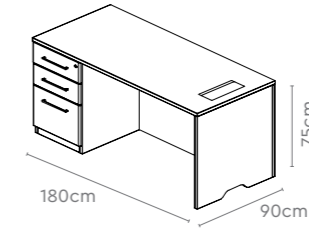

Main Table LH

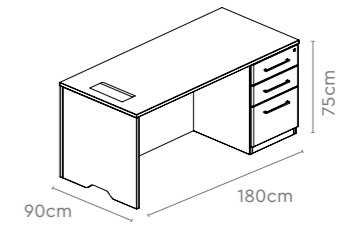

Back Unit 1

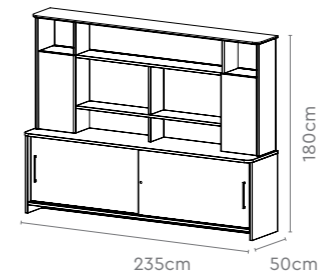

Back Unit 2

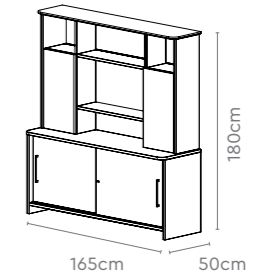

Back Unit 3

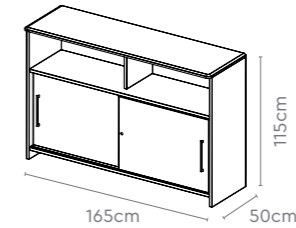

Back Unit 4

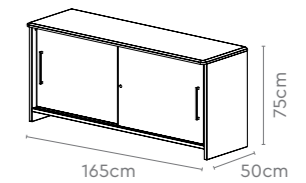

All sizes in cm

	Width	Depth	Height
Main Table	165.0	75.0	75.0
	180.0	90.0	75.0
Back Unit 1	235.0	50.0	180.0
Back Unit 2	165.0/180.0	50.0	180.0
Back Unit 3	165.0/180.0/235.0	50.0	115.0
Back Unit 4	165.0/180.0/235.0	50.0	75.0

Cignus



Design Registered



Features

- The swan-like flowing design of the Cignus desk is aesthetically highlighted with its contrasting colour scheme.
- All of its back units blend seamlessly with the main table, creating a rich and aesthetic office space.
- The flowing lines on the Cignus continue on its modesty, with a slanted cut to the panel that perfectly complements the return unit.

In the set above

Cignus Executive Suite

Main Table

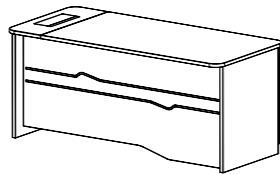

Back Unit 4

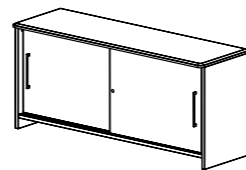

Back Unit 1

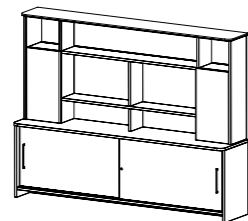

Back Unit 2

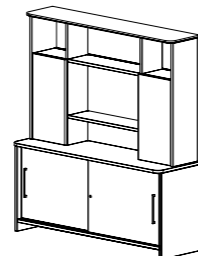

Pair with

Back Unit 3

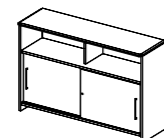

Greta 2.0 High Back Chair

→ Pg 92



Cignus Executive Suite

Measurements

Main Table RH

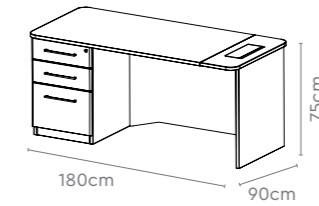

Main Table LH

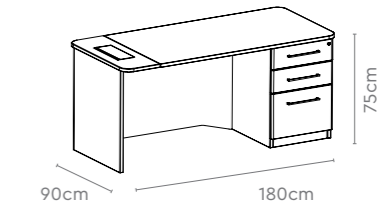

Back Unit 1

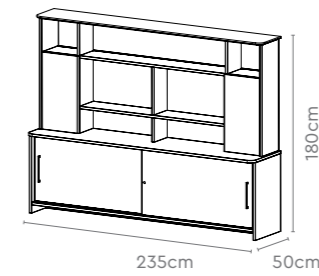

Back Unit 2

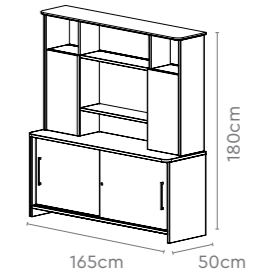

Back Unit 3

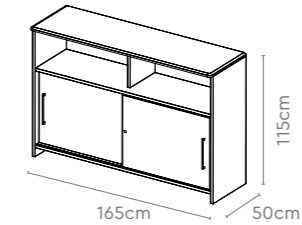

Back Unit 4

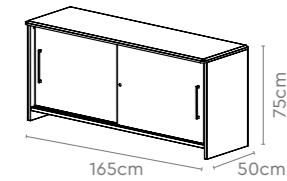

All sizes in cm

	Width	Depth	Height
Main Table	165.0	75.0	75.0
	180.0	90.0	75.0
Back Unit 1	235.0	50.0	180.0
Back Unit 2	165.0/180.0	50.0	180.0
Back Unit 3	165.0/180.0/235.0	50.0	115.0
Back Unit 4	165.0/180.0/235.0	50.0	75.0

Trident Senior



Features

- The Trident Senior features a floating top with rounded edges that give it a comfortable finish.
- This two-piece workspace setup comprises of an executive desk and credenza with open shelf space.
- The tops of the desk and the credenza are made from Medium Density Fibreboard (MDF), and covered with membrane foil to provide for a scratch- and stain-resistant work surface.

Measurements

Executive Desk

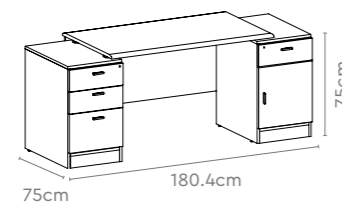

Credenza

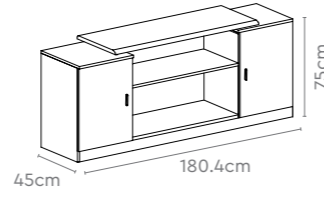

Pair with

Aero High Back Chair

→ Pg 95



All sizes in cm	Width	Depth	Height
Executive Desk	180.4	75.0	75.0
Credenza	180.4	45.0	75.0

Trident Middle



Features

- Complete with an executive desk and a side unit, the Trident Middle comes in a compact form.
- While it's best suited for offices with limited cabin space, this desk packs a spacious in-built shelf for storing documents and personal belongings.
- Side unit available with an in-built pull-out keyboard tray.
- Can be configured LHS or RHS to suit your cabin layout.

Measurements

Middle Desk RH

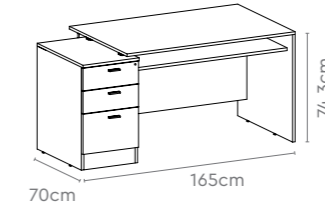

Middle Desk LH

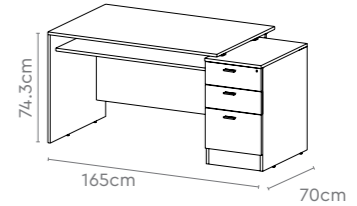

Side Unit (ERU) RH

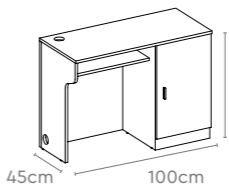

Side Unit (ERU) LH

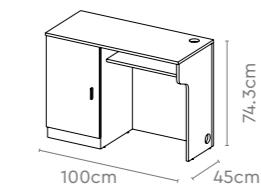

Pair with

Thrill Mesh Plus

→ Pg 94



All sizes in cm	Width	Depth	Height
Executive Desk	165.0	70.0	74.3
Side Unit	100.0	45.0	74.3



Mayfair



Features

- The Mayfair is a versatile desk that enlivens the ambience of every cabin it's in.
- Its unique colour combination of White Cedar and Black gives it a clean look, that goes well with any office setting.
- The executive desk and side unit come equipped with grommets for wire management, and a clutter-free desktop.
- Comes in a variety of sizes for different cabin layouts, and the main desk can be complemented with a matching pedestal, side unit, and credenza.

Measurements

Executive Desk

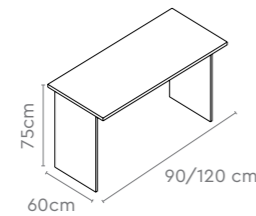

Side Unit

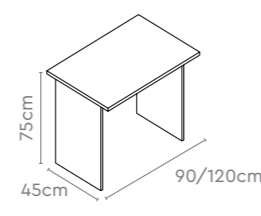

Mobile Pedestal

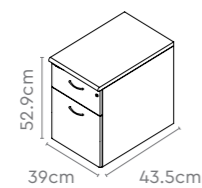

Credenza

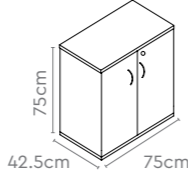

Pair with

Aero High Back Chair

→ Pg 95



All sizes in cm	Width	Depth	Height
Executive Desk	90.0/120.0	60.0	75.0
	135.0	75.0	75.0
Side Unit	90.0/120.0	45.0	75.0
Mobile Pedestal	39.0	43.5	52.9
Credenza	75.0	42.5	75.0

Ascent



Features

- The Ascent is an all-in-one desking solution.
- Its wide floating top makes it spacious enough to accommodate a monitor, work files, and personal décor.
- Comes with a raised-leg design for easy cleaning.
- Built-in utility trays, pull-out keyboard tray, storage and CPU-space helps you organise your workspace better.

Measurements

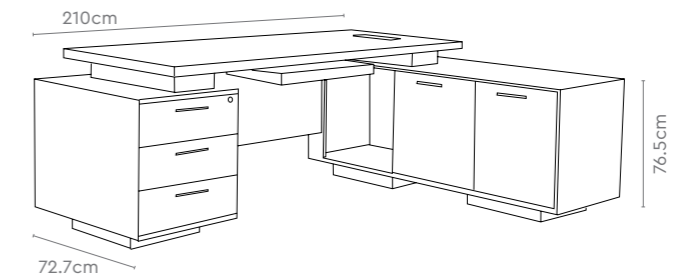

Pair with

Greta 2.0 High Back Chair

→ Pg 92



All sizes in cm	Width	Depth	Height
Overall	210.0	72.7	76.5
Executive Desk	180.0	79.5	76.5
ERU	160.0	50.0	65.0

Finesse



Features

- The Finesse Desk offers options of LHS or RHS configuration to suit any cabin layout.
- Pair your executive desk with a matching side unit and HDU storage unit for a seamless workspace.
- Executive desks and side units are available in different sizes to suit varying cabin sizes.
- Convenient cut-outs on the worktop for efficient and clutter-free wire management.

Measurements

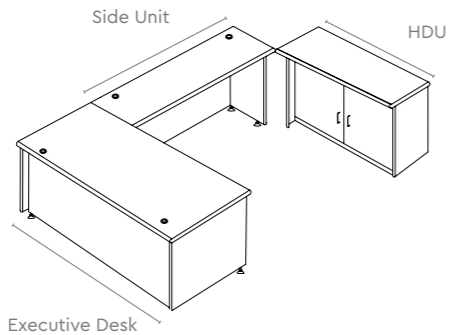

All sizes in cm	Width	Depth	Height
Executive Desk 1	120.0	60.0	74.0
Executive Desk 2	150.0	75.0	74.0
Executive Desk 3	165.0	90.0	74.0
Executive Desk 4	180.0	90.0	74.0
ERU 1	105.0	45.0	70.5
ERU 2	155.0	45.0	70.5
HDU	128.0	42.5	70.5

Executive Desk 2 comes as a set with ERU 1.

Pair with

Thrill Executive High Back Chair

→ Pg 87



T-22 Unitized Table



Features

- The T-22 Unitized table has a clean and minimalistic aesthetic.
- Comes with an integrated switch box for power access, and a soft-closing access flap for easy cable management.
- Available in multiple sizes and module configurations.

Measurements

T-22 Unitized Table

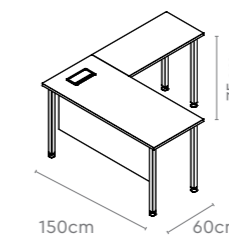

All sizes in cm	Width	Depth	Height
T-22 Unitized Table	150.0	60.0	75.0
	150.0/180.0	75.0	75.0
Wooden Pedestal	40.0	45.0	64.0



Pair with

Wooden Pedestal

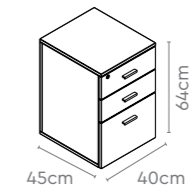

Beat High Back Chair

→ Pg 88



T-25 Unitized Table



Design Registered



Features

- The T-25 Unitized table has a clean and minimalistic aesthetic.
- Comes with an integrated switch box for power access, and a soft-closing access flap for easy cable management.
- Finished with an integrated storage unit with a drawer and HDU combination, and a modesty panel at the visitor's end.
- Available in multiple sizes and module configurations.

Measurements

T-25 Unitized Table

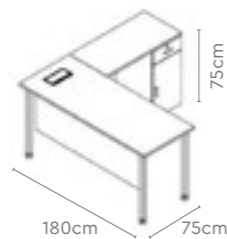

Pair with

Beat High Back Chair

→ Pg 88



All sizes in cm	Width	Depth	Height
T-25 Unitized Table	150.0	60.0	75.0
	150.0/180.0	75.0	75.0

Enterprise



Design Registered



Features

- The Enterprise office desk has copious storage housed within a compact design.
- Available in a variety of sizes, with the 150 and 165 cm width variants featuring a wooden modesty panel for privacy.
- Wire slots are provided in the top frame for efficient wire management. A vertical and horizontal wire carrier ensures a clutter-free and organised desk space.
- You can accessorise the Enterprise table with a CPU mount, to free up floor space.

Measurements

LH Table

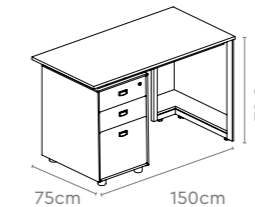

RH Table

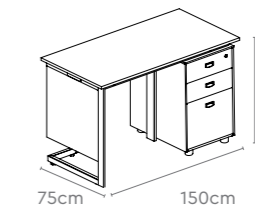

Pedestal

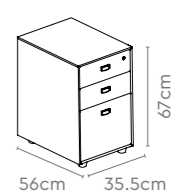

All sizes in cm	Width	Depth	Height
Executive Desk (LH/RH unit)	120.0	60.0	72.8
	135.0/150.0	75.0	72.8
	165.0	90.0	72.8

Modesty Panel given in 150 and 165cm width variants only.

Work



Features

- This all-wooden desk comes equipped with a free-standing three-drawer pedestal for storing files, papers, and personal belongings.
- You can also accessorise it with a CPU trolley and a keyboard pull-out tray.
- Comes with wire management cut-outs on both the side panels for a clutter-free desktop.

Measurements

Work Desk 1

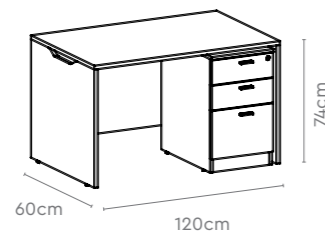

All sizes in cm	Width	Depth	Height
Work Desk 1	120.0	60.0	74.0
Work Desk 2	150.0	75.0	74.0

Aristo



Design Registered



Features

- The Aristo comes complete with softened corners and chamfered edges that offer user comfort and convenience.
- Its simple horizontal line pattern and dark wood grains make for an elegant finish.
- The soft-close sliding doors, with aluminium handles for back units, ensure ease of operation.

Measurements

Main Table 1

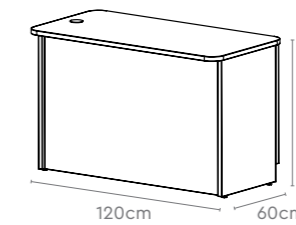

Main Table 2

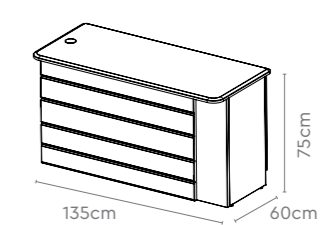

All sizes in cm	Width	Depth	Height
Main Table 1	120.0	60.0	75.0
Main Table 2	135.0	60.0	75.0

Topaz



Design Registered



Features

- The clean lines on the Topaz desk surface blend well with its raw wood grain and aesthetic door handles.
- Geometric lines run throughout the panel, making optimum use of lighter shades to present a uniform and neat look.
- The unique pattern on the fascia and the modesty panel, ups the style quotient of any space the Topaz sits in.

Measurements

Main Table 1

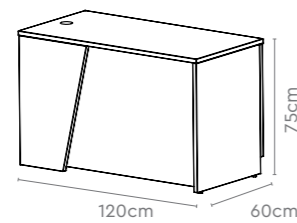

Main Table 2

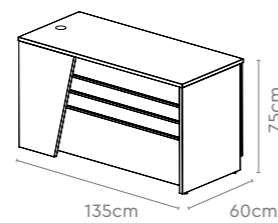

All sizes in cm	Width	Depth	Height
Main Table 1	120.0	60.0	75.0
Main Table 2	135.0	60.0	75.0

Cignus



Design Registered



Features

- The swan-like flowing design of the Cignus desk is aesthetically highlighted with its contrasting colour scheme.
- All of its back units blend seamlessly with the main table, creating a rich and aesthetic office space.
- The flowing lines on the Cignus continue on its modesty, with a slanted cut to the panel that perfectly complements the return unit.

Measurements

Main Table 1

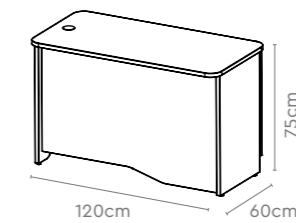

Main Table 2

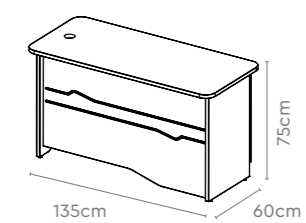

All sizes in cm	Width	Depth	Height
Main Table 1	120.0	60.0	75.0
Main Table 2	135.0	60.0	75.0

Unitized Table



Features

- The Unitized table is part of a range of sleek, efficient desking solutions for clutter-free workspace.
- Select models feature a footrest for added comfort.
- Multiple drawer combinations are available to meet your storage requirements.
- Available in both round and tubular understructure.
- Features a laminate top and powder-coated structure, available in various colour combinations.

Measurements

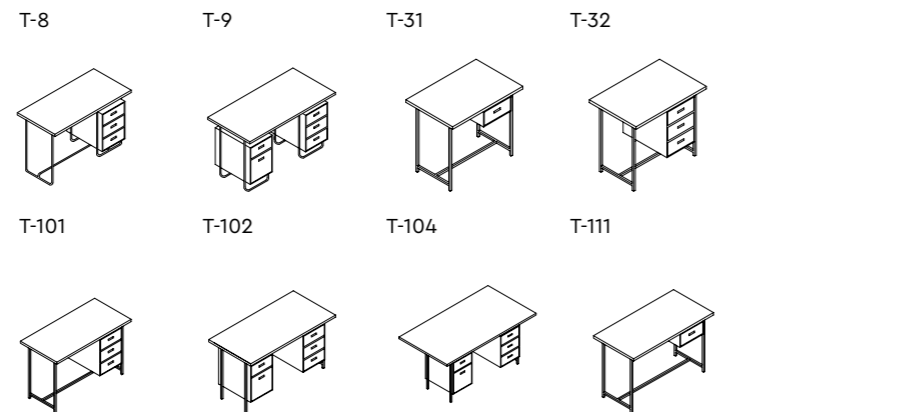

All sizes in cm	Width	Depth	Height
T-8	119.9	59.0	73.5
T-9	136.5	68.0	73.5
T-31	90.0	59.0	75.0
T-32	90.0	59.0	75.0
T-101	119.9	59.0	75.0
T-102	136.5	68.0	75.0
T-104	166.5	90.0	75.5
T-111	119.9	59.0	75.0

Unitized Table

Measurements

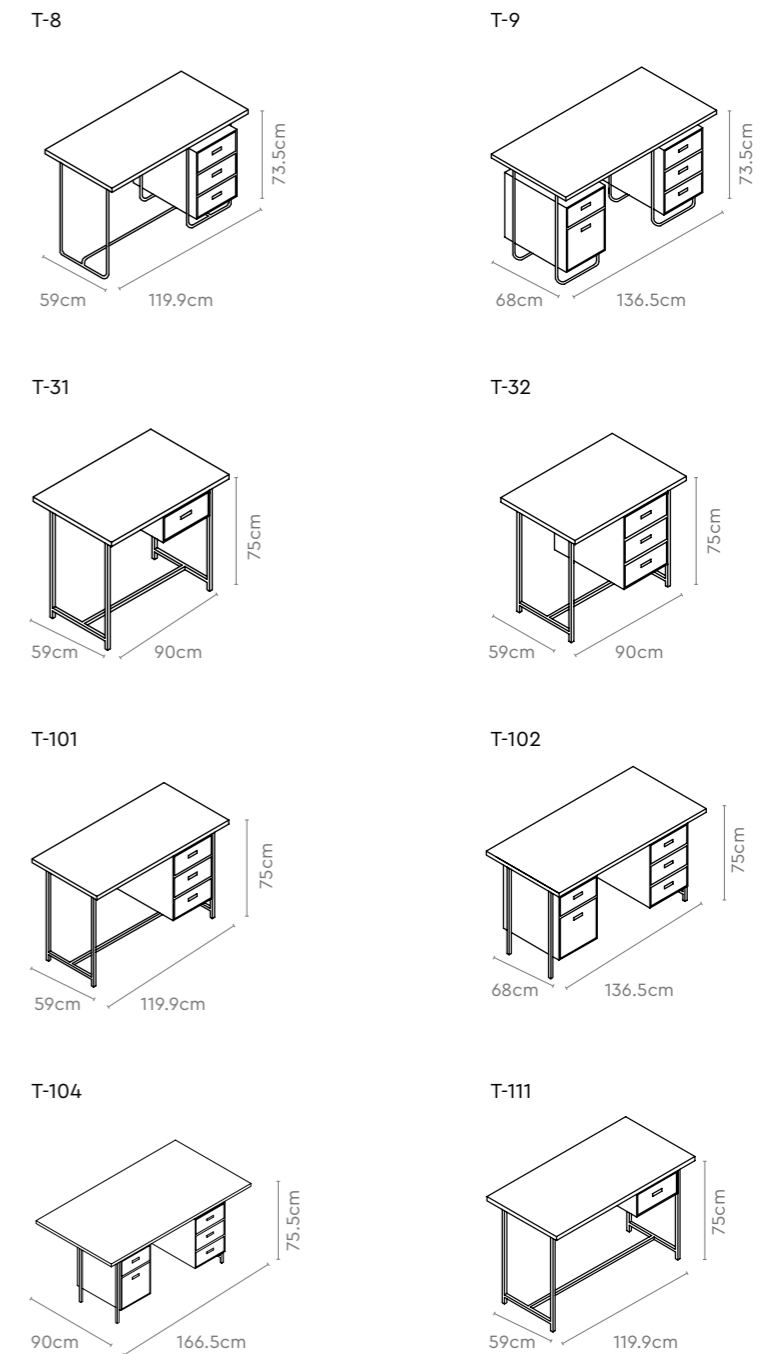

T-20 Unitized Table



Design Registered

Features

- The T-20 Unitized table has a clean and minimalistic aesthetic.
- Comes with an integrated switch box for power access, and a soft-closing access flap for easy cable management.
- Finished with a mobile wooden three-drawer pedestal and a modesty panel at the visitor's end.
- Available in multiple sizes and module configurations.

Measurements

T-20 Unitized Table

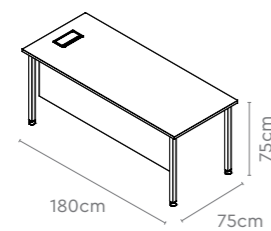

Pair with
Wooden Pedestal

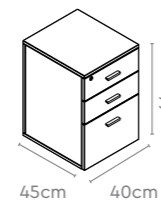

All sizes in cm	Width	Depth	Height
T-20 Unitized Table	135.0/150.0/180.0	75.0	75.0
	120.0/150.0	60.0	75.0
Wooden Pedestal	40.0	45.0	64.0

Trident Junior



Features

- The Trident Junior is a trendy, space-saving desk perfect for compact environments.
- The all-wood design in a dual-tone finish adds elegance, durability, and warmth, enhancing any office space.
- Occupying minimal floor area, the table has a modesty panel, a lockable drawer, and a cabinet for storing files and personal items.

Measurements

Trident Junior

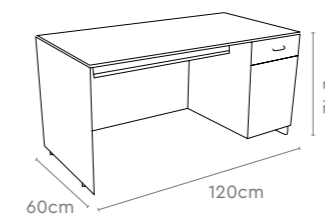

All sizes in cm	Width	Depth	Height
Trident Junior 1	120.0	60.0	74.3
Trident Junior 2	150.0	75.0	74.3

Stylo

Features

- Compact form, timeless design, durable construction.
- The Stylo office desk in all-wood construction aesthetically fits into any and every workspace.
- The pull-out keyboard tray frees up the surface area.
- Its flexible combination of concealed and open storage provides ample space.
- Drawers can be used for notebooks, calculators, tiffins, etc. The larger spaces can be used for a CPU, a laptop bag, large folders and other such office items.



Measurements

Stylo

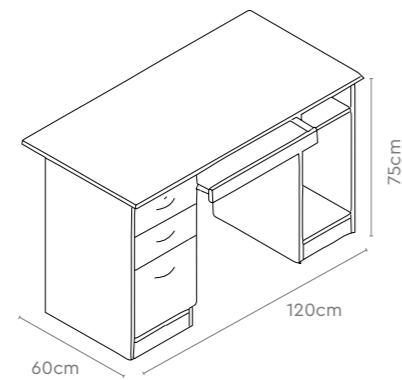

All sizes in cm	Width	Depth	Height
Stylo	120.0	60.0	75.0

Enzo



Features

- The Enzo table is a compact all-wooden table that's aesthetic and functional.
- Can be customised with variable drawer combos to meet your specific needs.
- The drawers are lockable to ensure safe storage of all your valuables.

Measurements

Enzo - Variant 1

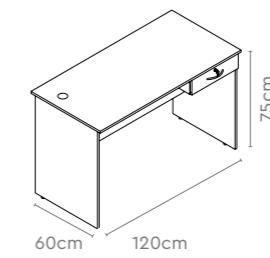

Enzo - Variant 2

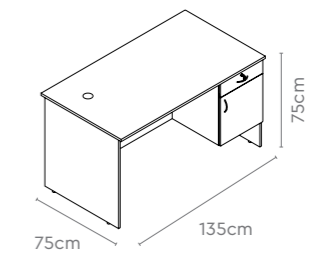

Enzo - Variant 3

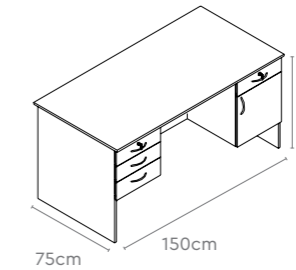

All sizes in cm	Width	Depth	Height
Enzo	120.0	60.0	75.0
	135.0/150.0	75.0	75.0

Modular

Mingle Concept



Features

- Modular is a Mingle Range conference table that can be configured to accommodate as many seats as you want it to.
- Cantilevered design provides unobstructed and ample leg space for comfortable meetings.
- The provision of a power module under the worktop keeps your desk clutter-free, and the cable holders allow for easy access while keeping your cables tangle-free.
- Available in PLT and MEM options.

In the set Modular Conference Table

Straight (Main/Shared/End of LH & RH)



Straight (Shared)



Corner Module

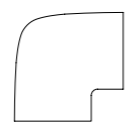

V1 Corner

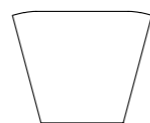

V2 Corner

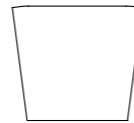

V1 Head Module (1459mm)

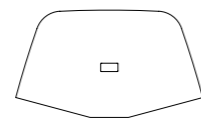

V2 Head Module (1509mm)

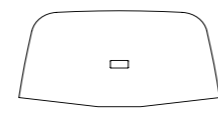

H1 Head Module (1800mm)

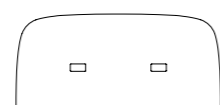

H2 Head Module (2350mm)

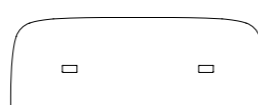

Modular

Closed Layout

H1 Head Module

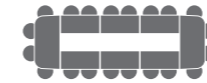

H2 Head Module

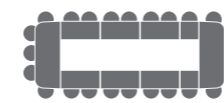

Corner Module

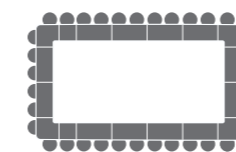

V1 and V2 Head Module



Measurements

Straight (Main/Shared/End of LH & RH)

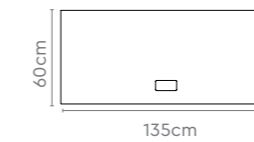

H1 Head Module (1800mm)

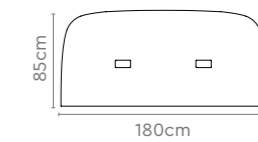

Straight (Main/Shared/End of LH & RH)

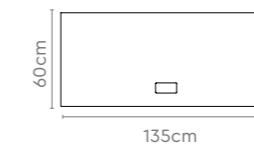

H2 Head Module (2350mm)

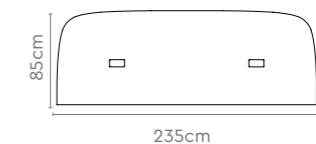

Straight (Shared)

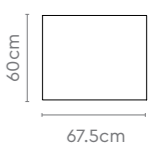

Straight (Main/Shared/End of LH & RH)

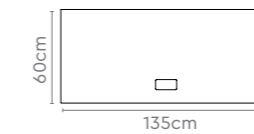

Corner Module



Straight (Main/Shared/End of LH & RH)

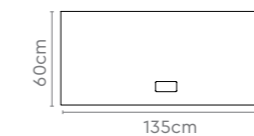

Corner Module



Straight (Shared)

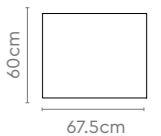

Straight (Main/Shared/End of LH & RH)

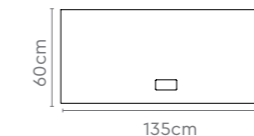

V1 Head Module (1459mm)

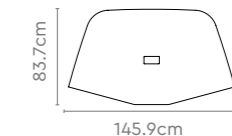

V1 Corner

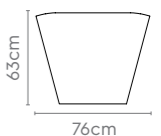

or

V2 Head Module (1509mm)

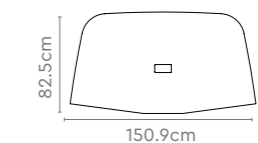

V2 Corner

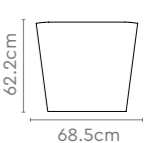

Modular

Open Layout

H1 Head Module



H2 Head Module



Corner Module

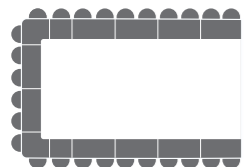

V1 and V2 Head Module

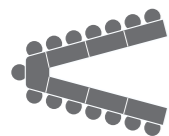

Measurements

Straight (Main/Shared/End of LH & RH)

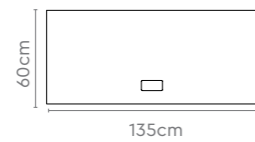

H1 Head Module (1800mm)

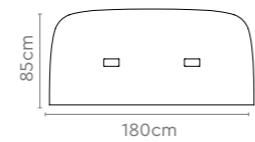

Straight (Shared)

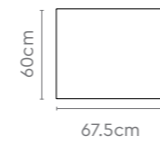

Straight (Main/Shared/End of LH & RH)

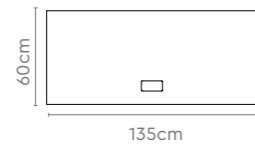

H2 Head Module (2350mm)

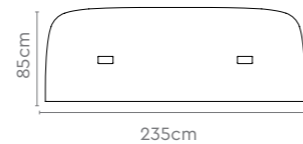

Straight (Main/Shared/End of LH & RH)

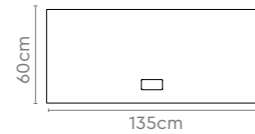

Corner Module

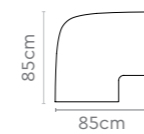

Straight (Main/Shared/End of LH & RH)

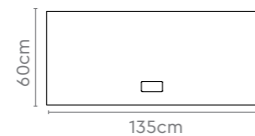

Corner Module

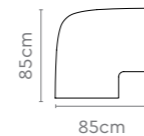

Straight (Shared)

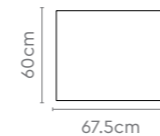

Straight (Main/Shared/End of LH & RH)

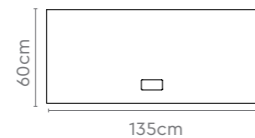

V1 Head Module (1459mm)

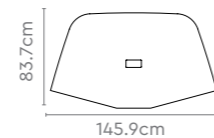

V1 Corner

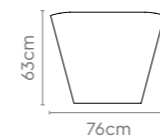

or

V2 Head Module (1509mm)

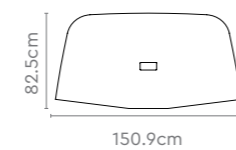

V2 Corner

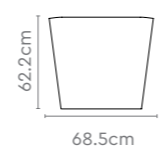

Elegance AV

Mingle Concept



Features

- Elegance AV is a modular conference table that can be configured to accommodate any number of seats.
- The cantilever module design of this product offers plenty of legroom, ensuring comfortable meetings.
- Includes a convenient full-length wooden access flap, providing easy access to power and data. Keep your desk clutter-free with a power module conveniently tucked away under the tabletop.
- Option to include an integrated cable cubby with a retractor provision.

In the set Elegance AV Conference Table

Straight (Main/Shared/End of LH & RH)



Straight (Shared)

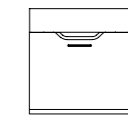

Pair with
**La Sede
Mid
Back
Chair**

→ Pg 82



Corner Module



V1 Corner

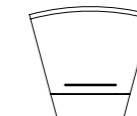

V2 Corner

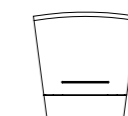

V1 Head Module

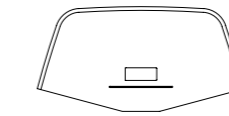

V2 Head Module

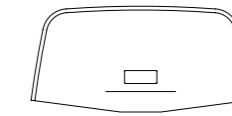

H1 Head Module (1800mm)

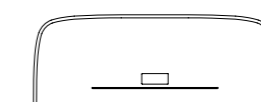

H2 Head Module (2360mm)

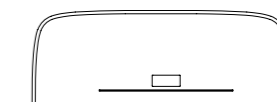

Elegance AV

Closed Layout

H1 Head Module



Measurements

Straight
(Main/Shared/End of LH & RH)

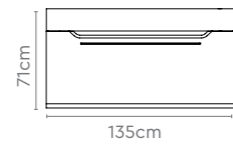

H1 Head Module
(1800mm)

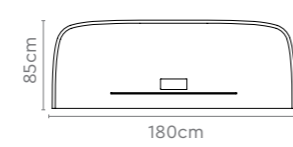

H2 Head Module



Straight
(Main/Shared/End of LH & RH)

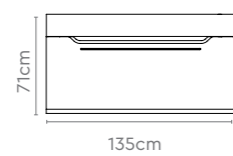

H2 Head Module
(2350mm)

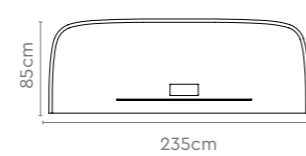

Straight
(Shared)

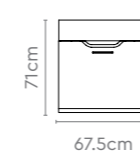

Corner Module

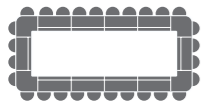

Straight
(Main/Shared/End of LH & RH)

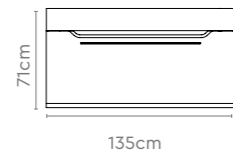

Corner Module

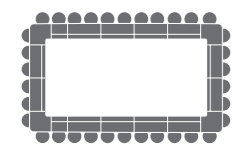
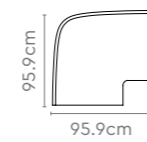

Straight
(Main/Shared/End of LH & RH)

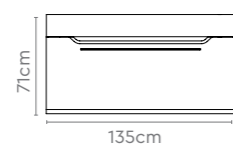

Corner Module

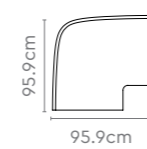

Straight
(Shared)

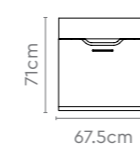

V1 and V2 Head Module



Straight
(Main/Shared/End of LH & RH)

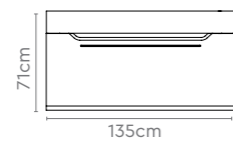

V1 Head Module
(1670mm)

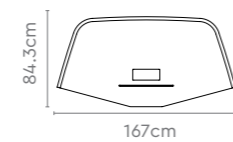

V1 Corner

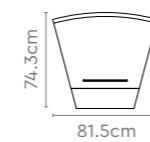

or

V2 Head Module
(1726mm)

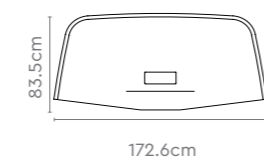

V2 Corner

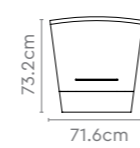

Elegance AV

Open Layout

H1 Head Module



Measurements

Straight
(Main/Shared/End of LH & RH)

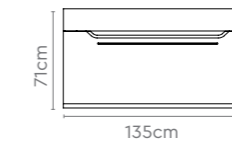

H1 Head Module
(1800mm)

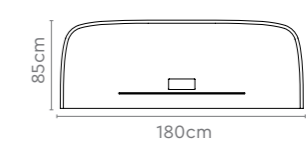

Straight
(Shared)

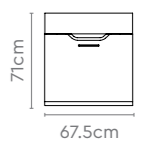

H2 Head Module



Straight
(Main/Shared/End of LH & RH)

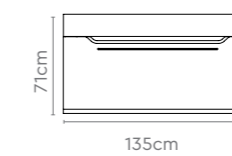

H2 Head Module
(2350mm)

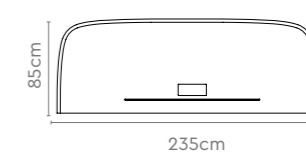

Corner Module

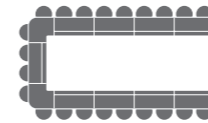

Straight
(Main/Shared/End of LH & RH)

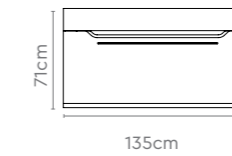

Corner Module

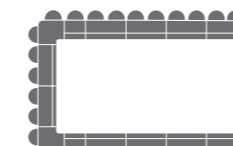
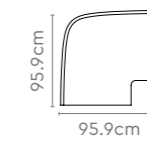

Straight
(Main/Shared/End of LH & RH)

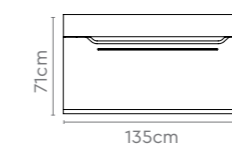

Corner Module

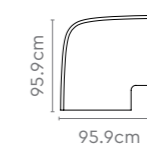

Straight
(Shared)

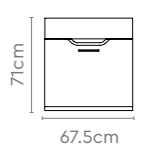

V1 and V2 Head Module

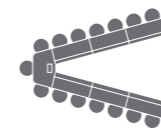

Straight
(Main/Shared/End of LH & RH)

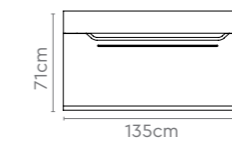

V1 Head Module
(1670mm)

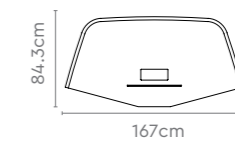

V1 Corner

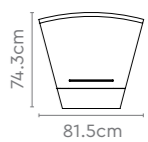

or

V2 Head Module
(1726mm)

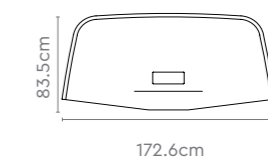

V2 Corner



Unitized

Mingle Concept



Features

- Unitized is a sophisticated conferencing solution that ensures a clear screen view and easy access to power and AV connectivity.
- A concealed wire management system under the worktop keeps your desk clutter-free.
- Offered in both PLT and MEM options. MEM option includes Unitized AV.

In the set Unitized Conference Table

PLT & Membrane Range

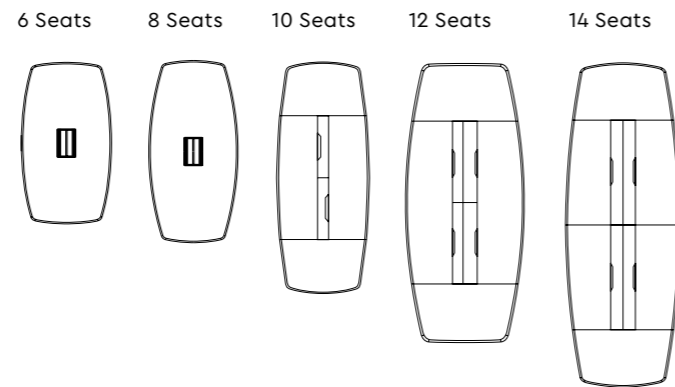

AV Range

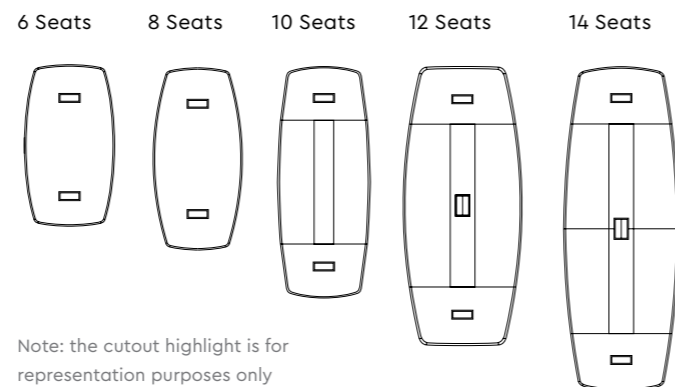

Note: the cutout highlight is for representation purposes only

Unitized Conference Table

Measurements

PLT & Membrane Range

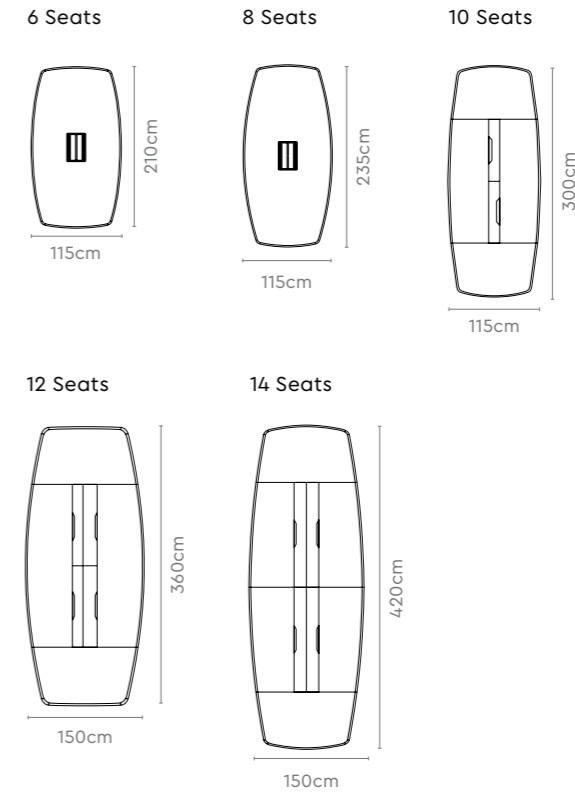

AV Range

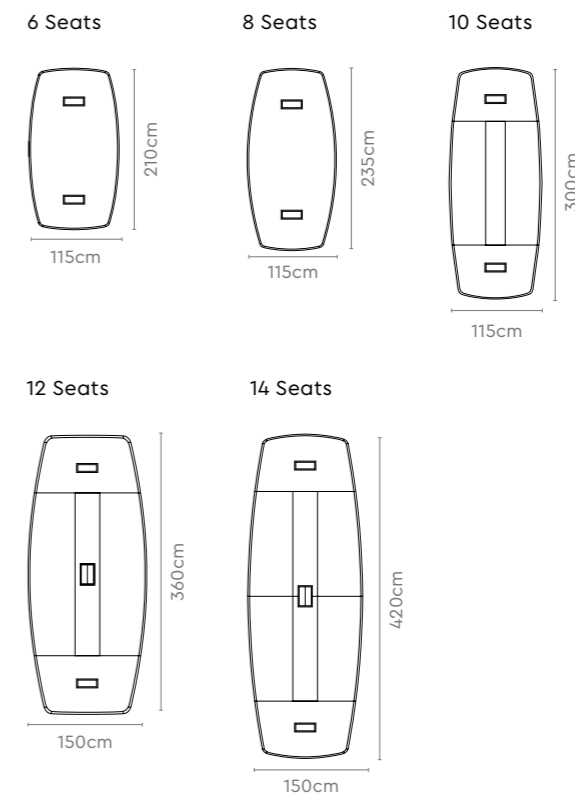

Gather

Mingle Concept



Features

- This conference table, boasting a contemporary design and aesthetics, is best-suited for modern workspaces.
- It comes equipped with a central power module for easy power and data connectivity.
- Inject life into your workspace by pairing this table with the Gather range of accessories.
- Available in PLT and MEM options.

Measurements

4 Seater

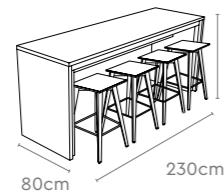

10 Seater

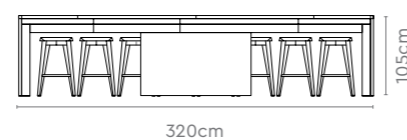

16 Seater

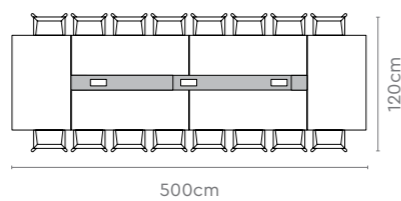

Pair with
**Radix
Hi-Stool**

→ Pg 208



All sizes in cm	Width	Depth	Height
4 Seater	230.0	80.0	105.0
10 Seater	320.0	120.0	105.0
16 Seater	500.0	120.0	105.0

VC Colab

Mingle Concept



Features

- This AV-integrated conference table is equipped to take on the demands of the digital era.
- It comes in an aesthetically-pleasing design with a waterfall edge, and a worktop that offers optimal viewing experience to all its users.
- Eliminates the need for a special video conferencing room, and can also be used to nurture collaborative workspaces.
- Concealed channels provided to route wires and ensure a clutter and tangle-free workspace.

Measurements

Standard Seating

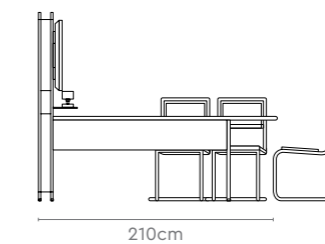

High Seating

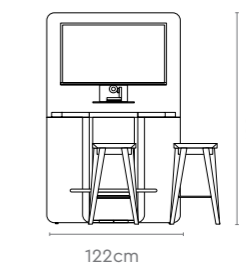
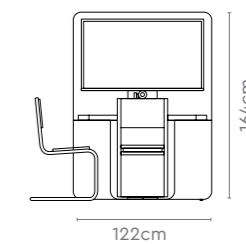
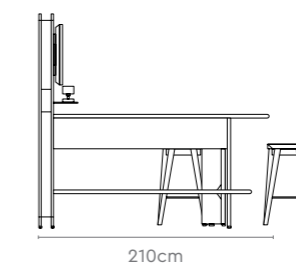

Pair with
**Scintilla
High
Chair**



All sizes in cm	Width	Depth	Height
Standard Seating	210.0	122.0	164.0
High Seating	210.0	122.0	192.0

POD

Mingle Concept



Features

- The Mingle Pod is equipped with an access flap for easy power and data connectivity.
- The provision of a concealed wire management system under the worktop keeps your desk clutter-free.
- It comes in an aesthetically-pleasing design, and a worktop that offers optimal viewing experience to all its users.
- Available in PLT and MEM options.

Measurements

Circular

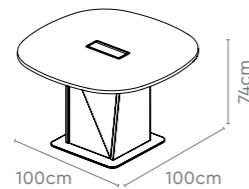

Square

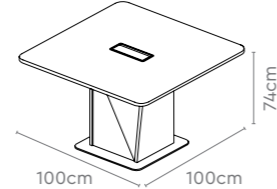

Pair with

Motion High Back



All sizes in cm	Width	Depth	Height	DIA
Circular	-	-	74.0	100.0/115.0
Square	100.0/115.0	100.0/115.0	74.0	-



Conclave



Features

- This classy table is complete with a black back-painted glass top, made out of 12 mm thick toughened glass.
- Plug-and-play data and power points available for individual users, with an in-built concealed wire management system for a clean, neat, and clutter-free tabletop.
- Additional concealed storage available to keep supporting material within reach during discussions.

Measurements

8 Seater (Curvilinear Top)

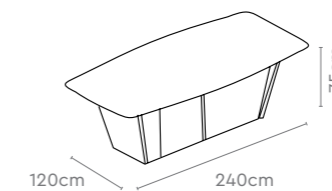

8 Seater (Straight Top)

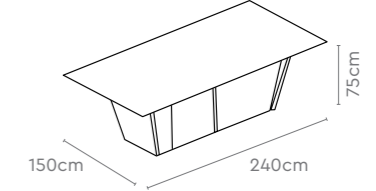

10 Seater (Curvilinear Top)

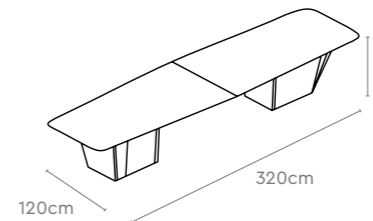

10 Seater (Straight Top)

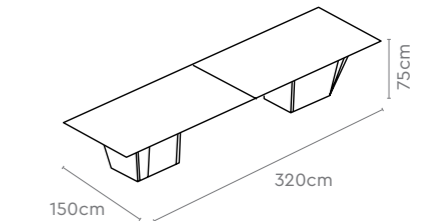

All sizes in cm	Width	Depth	Height
8 Seater Curve/Straight Top	240.0	120.0/150.0	75.0
10 Seater Curve/Straight Top	320.0	120.0/150.0	75.0
12 Seater Curve/Straight Top	400.0	120.0/150.0	75.0
14 Seater Curve/Straight Top	480.0	120.0/150.0	75.0

Reflection



Design Registered



Reflection

Features

- The Reflection reception table comes with a biophilic colour scheme that mirrors natural materials, making your office space feel more timeless and classy.
- The two levels of the table space enable seamless interaction with standing visitors, and with those with special needs.
- Dual-tone desk-front provides ample space to display your branding.
- Grommets included in the desks to tackle cables from landlines and printers.

Measurements

Linear 5 Feet



Linear 8 Feet



L-Shaped 8 Feet



All sizes in cm

	Width	Depth	Height
Linear 5 Feet	150.0	87.0	108.0
Linear 8 Feet	240.0	87.0	108.0
L-Shaped 8 Feet	240.0	177.0/87.0	108.0

Flip NXT

Features

- The Flip NXT table lives up to its name as it easily flips up to create extra space whenever needed.
- With 360-degree rotating castors and a convenient handle, this table effortlessly flips up and down, ensuring a smooth experience.
- Comes in a sleek, compact, and lightweight design with rounded corners to avoid injury.
- Thanks to its unique leg design and understructure, the Flip NXT table blends well and is visually appealing.



Measurements

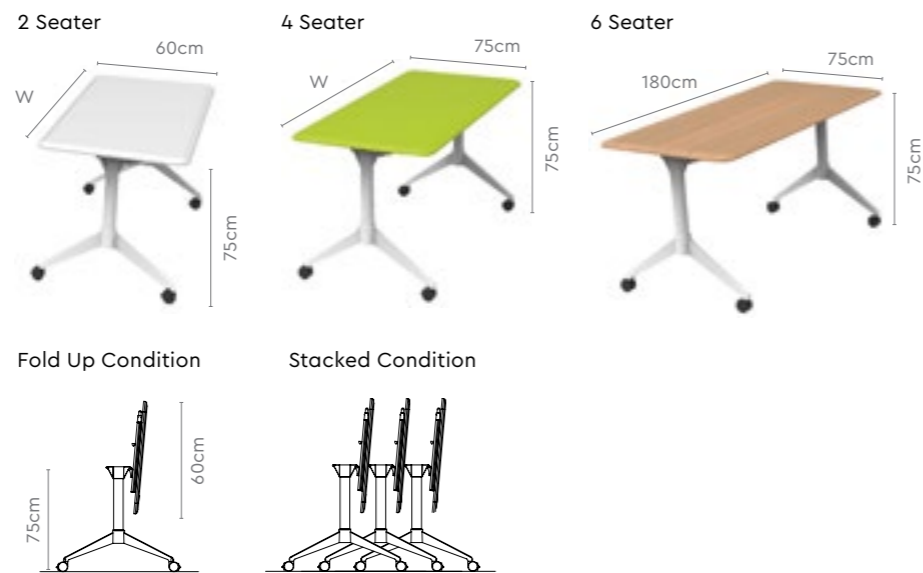

All sizes in cm	Width	Depth	Height
2 Seater	120.0/135.0	60.0	75.0
4 Seater	150.0/165.0	75.0	75.0
6 Seater	180.0	75.0	75.0

Café Pod

Features

- The Café Pod provides a clean and sanitary cafeteria environment.
- The tables can be easily folded and stacked when not in use.
- The serrated stainless steel pedestal increases sturdiness and adds a stylish touch.



Measurements



Folded Condition



All sizes in cm	Width	Depth	Height
Rubber Wood Top/Concave	80.0	80.0	73.8
Stainless Stool Top/Straight	80.0	80.0	74.25
PU Top/Convex	80.0	80.0	74.5

Time Out

Features

- Revitalize your cafeteria and breakout areas by incorporating the trendy Time Out series, bringing a vibrant burst of color.
- Designed to look fresh for years, the table surfaces and understructure are also easy to clean and maintain.
- With its sleek and stackable design, the Time Out maximises space management for the user.
- Available in two options: a PU-coated top with a powder-coated understructure, and a membrane top with a stainless steel understructure.
- Comes in four-, six-, and eight-seater configurations.



Design Registered



Measurements

4 Seater



6 Seater

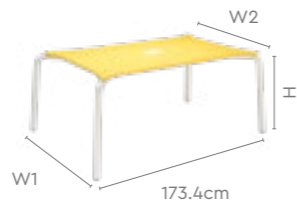

8 Seater



Bottom View

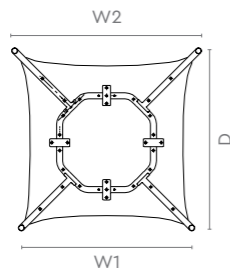

All sizes in cm	Width 1	Width 2	Depth	Height
4 Seater	109.0	117.5	113.5	75.0
6 Seater	109.0	117.5	173.4	75.0
8 Seater	109.0	117.5	232.9	75.0

Upbeat Café Tables



Features

- This high table from the Upbeat range has been designed to provide a richer work experience in modern offices.
- Comes in two types of legs and tabletop options, providing versatility and style to any cafeteria space it's in.
- The seamless worktop comes laminated on both sides.
- Finished with cross members for additional stability.

Measurements

Upbeat Café Table with Swing Leg



Pair with

Dfine Plus Leg



All sizes in cm	Width	Depth	Height
Upbeat Café Table - With Swing Leg (CL Top or PLB Top)	120.0/240.0	90.0	75.0
Upbeat Café Table - With Dfine Plus Leg (CL Top or PLB Top)	120.0/240.0	90.0	75.0

Relish

Features

- The stainless steel surface promotes cleanliness and hygiene, staying dry and moisture-free.
- The strength of the table is enhanced by particle board that supports the stainless steel top.
- Available in 2- and 4-seater options to suit your needs.
- The table can be used for serving meals, but also makes a delightful space for enjoying meals.



Measurements

Relish

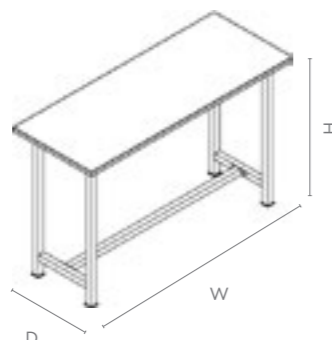

All sizes in cm	Width	Depth	Height
Relish 2 Seater	118.0	46.0	75.0
Relish 4 Seater	118.0	75.0	75.0

Cantina

Features

- The Cantina Table is thoughtfully designed to occupy minimal floor space while providing comfortable seating space for four.
- The stainless steel surface top with its brushed finish is resistant to scratches and easy to maintain.
- The level adjusters located in the feet ensure stability, even on uneven surfaces, enhancing its overall balance.
- The compact table frees up aisle space to facilitate easy movement.
- Comes in 2 variants: plastic shell seat and stainless steel stool.



Measurements

Cantina with Plastic Shell Seat

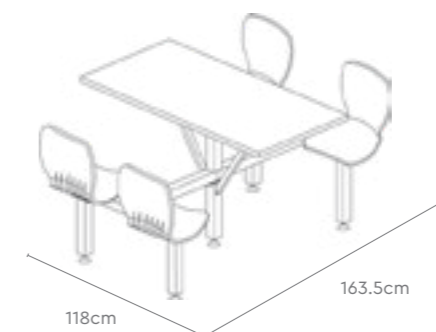

Cantina with Stainless Steel Stool



All sizes in cm	Width	Depth	Height
Cantina with Plastic Shell Seat	118.0	163.5	75.0
Cantina with Stainless Steel Stool	118.0	158.0	75.0